

Catalogo generale tecnico

General technical catalog

Safety valves homologated
2014/68/EU ATEX ASME VIII Div. 1
UV Canadian Reg. CRN EAC



Архангельск (8182)63-90-72
Астана (7172)727-132
Астрахань (8512)99-46-04
Барнаул (3852)73-04-60
Белгород (4722)40-23-64
Брянск (4832)59-03-52
Владивосток (423)249-28-31
Волгоград (844)278-03-48
Вологда (8172)26-41-59
Воронеж (473)204-51-73
Екатеринбург (343)384-55-89

Иваново (4932)77-34-06
Ижевск (3412)26-03-58
Иркутск (395)279-98-46
Казань (843)206-01-48
Калининград (4012)72-03-81
Калуга (4842)92-23-67
Кемерово (3842)65-04-62
Киров (8332)68-02-04
Краснодар (861)203-40-90
Красноярск (391)204-63-61
Курск (4712)77-13-04
Липецк (4742)52-20-81

Магнитогорск (3519)55-03-13
Москва (495)268-04-70
Мурманск (8152)59-64-93
Набережные Челны (8552)20-53-41
Нижний Новгород (831)429-08-12
Новокузнецк (3843)20-46-81
Новосибирск (383)227-86-73
Омск (3812)21-46-40
Орел (4862)44-53-42
Оренбург (3532)37-68-04
Пенза (8412)22-31-16

Пермь (342)205-81-47
Ростов-на-Дону (863)308-18-15
Рязань (4912)46-61-64
Самара (846)206-03-16
Санкт-Петербург (812)309-46-40
Саратов (845)249-38-78
Севастополь (8692)22-31-93
Симферополь (3652)67-13-56
Смоленск (4812)29-41-54
Сочи (862)225-72-31
Ставрополь (8652)20-65-13

Сургут (3462)77-98-35
Тверь (4822)63-31-35
Томск (3822)98-41-53
Тула (4872)74-02-29
Тюмень (3452)66-21-18
Ульяновск (8422)24-23-59
Уфа (347)229-48-12
Хабаровск (4212)92-98-04
Челябинск (351)202-03-61
Череповец (8202)49-02-64
Ярославль (4852)69-52-93

Киргизия (996)312-96-26-47 Казахстан (772)734-952-31 Таджикистан (992)427-82-92-69

<http://www.nuovagen.nt-rt.ru> || ngb@nt-rt.ru

Come scegliere una valvola scarico libero

How to choose a valve

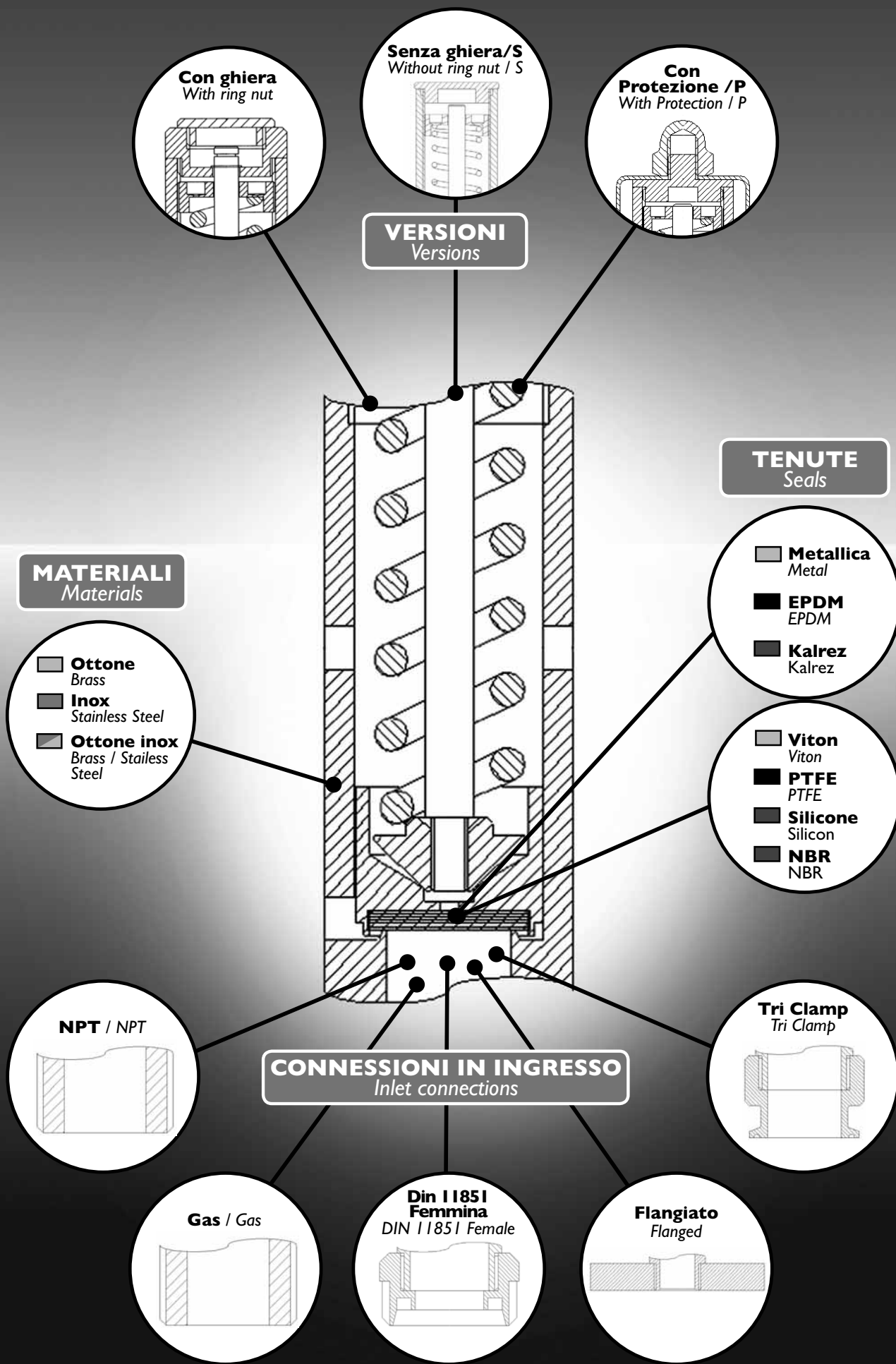

Come scegliere una valvola scarico convogliato

How to choose a valve

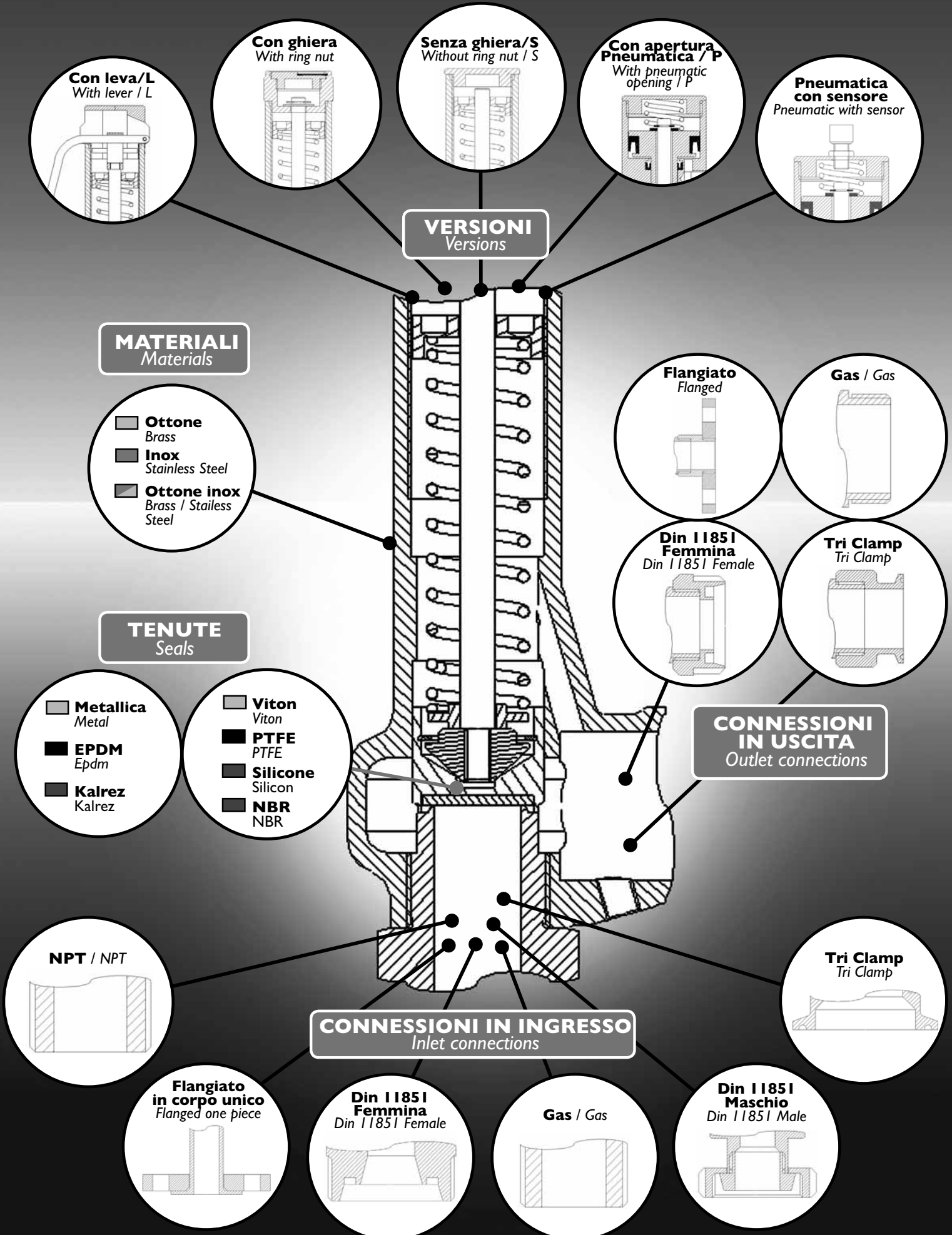

Valvole di sicurezza scarico libero

Safety valves free outlet

Calcolo portata di scarico valvola di sicurezza (ISO 4126-7 Ed.2013)

Safety Valve Fluid Delivery Calculation (ISO 4126-7 Ed.2013)

Tipo / Typ	Z7			D7			Z10			C10			D10			B12			Z14			D14			F18			
Fluido / Fluid	Aria Air	Azoto N2	CO2 CO2	Aria Air	Azoto N2	CO2 CO2	Aria Air	Azoto N2	CO2 CO2	Aria Air	Azoto N2	CO2 CO2	Aria Air	Azoto N2	CO2 CO2	Aria Air	Azoto N2	CO2 CO2	Aria Air	Azoto N2	CO2 CO2	Aria Air	Azoto N2	CO2 CO2	Aria Air	Azoto N2	CO2 CO2	
PS (bar)	kg/h	kg/h	kg/h	kg/h	kg/h	kg/h	kg/h	kg/h	kg/h	kg/h	kg/h	kg/h	kg/h	kg/h	kg/h	kg/h	kg/h	kg/h	kg/h	kg/h	kg/h	kg/h	kg/h	kg/h	kg/h	kg/h	kg/h	
1,0	52	51	63	58	57	69	106	105	128	100	98	120	112	110	134	157	154	188	209	205	251	210	206	252	357	351	428	
2,0	85	83	101	88	86	105	172	169	207	152	150	183	170	167	204	239	235	286	338	332	406	335	330	403	572	562	687	
3,0	119	117	143	118	116	142	243	239	292	205	201	246	229	225	274	321	315	385	478	470	573	472	464	566	807	793	969	
4,0	150	147	180	148	146	178	306	301	367	257	253	309	287	282	345	403	396	483	600	590	720	592	583	711	1013	996	121	
5,0	180	177	217	178	175	214	368	362	442	310	304	372	346	340	415	485	477	582	722	710	867	713	701	856	1220	1199	146	
6,0	211	208	253	208	205	250	430	423	517	362	356	435	404	397	485	567	557	680	844	830	1013	834	820	1001	1426	1402	171	
7,0	242	238	290	239	235	286	493	484	591	414	408	498	463	455	555	649	638	779	966	950	1160	955	939	1146	1633	1605	196	
8,0	272	268	327	269	264	323	555	546	666	467	459	561	521	512	626	731	719	877	1088	1070	1307	1075	1057	1291	1839	1808	220	
9,0	303	298	363	299	294	359	617	607	741	519	511	623	579	570	696	813	799	976	1211	1190	1453	1196	1176	1436	2045	2011	245	
10,0	333	328	400	329	324	395	679	668	816	572	562	686	638	627	766	895	880	1074	1333	1311	1600	1317	1295	1581	2252	2214	270	
15,0	486	478	583	480	472	576	991	974	1190	834	820	1001	930	915	1117	1305	1283	1567	1944	1911	2334	1920	1888	2305	3284	3229	394	
20,0				631	620	757									1223	1202	1468	1715	1686	2059			2523	2481	3030	4316	4244	518
25,0				782	769	939									1515	1490	1819	2125	2090	2551			3127	3075	3754			2
30,0				933	917	1120									1808	1777	2170	2535	2493	3044			3730	3668	4479			
35,0				1083	1065	1301									2100	2065	2521											
40,0				1234	1214	1482									2392	2352	2872											
45,0				1385	1362	1663									2685	2640	3223											
50,0				1536	1510	1844									2977	2927	3574											
55,0				1687	1659	2025									3270	3215	3925											
60,0				1838	1807	2206									3562	3502	4276											

A richiesta siamo in grado eseguire calcoli specifici per altri gas, temperature e pressioni

On request we can perform specific calculations for other gases, temperatures and pressures

Valvole di sicurezza scarico libero (Alta pressione)

Safety valves free outlet (High pressure)

Calcolo portata di scarico valvola di sicurezza (ISO 4126-7 Ed.2013)

Safety Valve Fluid Delivery Calculation (ISO 4126-7 Ed.2013)

Tipo / Typ	E10			E14		
Fluido / Fluid	Aria Air	Azoto N2	CO2 CO2	Aria Air	Azoto N2	CO2 CO2
PS (bar)	kg/h	kg/h	kg/h	kg/h	kg/h	kg/h
1	123	121	148	253	249	304
2	188	185	225	386	379	463
3	252	248	303	518	510	622
4	317	312	380	651	640	782
5	381	375	458	784	770	941
6	446	439	535	916	901	1100
7	511	502	613	1049	1031	1259
8	575	566	691	1181	1162	1418
9	640	629	768	1314	1292	1578
10	704	692	846	1447	1422	1737
15	1027	1010	1233	2110	2074	2533
20	1350	1327	1621	2773	2726	3329
25	1673	1645	2008	3436	3378	4125
30	1995	1962	2396	4099	4030	4921

Tipo / Typ	E10			E14		
Fluido / Fluid	Aria Air	Azoto N2	CO2 CO2	Aria Air	Azoto N2	CO2 CO2
PS (bar)	kg/h	kg/h	kg/h	kg/h	kg/h	kg/h
35	2318	2279	2783	4762	4682	5717
40	2641	2597	3171	5425	5334	6513
45	2964	2914	3558	6088	5986	7309
50	3286	3232	3946	6751	6638	8105
55	3609	3549	4333	7414	7290	8901
60	3932	3866	4721	8077	7942	9697
65	4255	4184	5108	8740	8594	10493
70	4578	4501	5496	9403	9246	11289
75	4900	4819	5883	10066	9898	12085
80	5223	5136	6271	10729	10550	12881
85	5546	5453	6658	11392	11202	13677
90	5869	5771	7046	12055	11854	14473
95	6192	6088	7433	12718	12506	15269
100	6514	6405	7821	13381	13157	16065

A richiesta siamo in grado eseguire calcoli specifici per altri gas, temperature e pressioni

On request we can perform specific calculations for other gases, temperatures and pressures

Tipo Typ	Z20			B20			Z25			F25			Z32			F32			B38			F40			
Fluido Fluid	Aria Air	Azoto N2	CO2 CO2	Aria Air	Azoto N2	CO2 CO2	Aria Air	Azoto N2	CO2 CO2	Aria Air	Azoto N2	CO2 CO2	Aria Air	Azoto N2	CO2 CO2	Aria Air	Azoto N2	CO2 CO2	Aria Air	Azoto N2	CO2 CO2	Aria Air	Azoto N2	CO2 CO2	
PS (bar)	kg/h	kg/h	kg/h	kg/h	kg/h	kg/h	kg/h	kg/h	kg/h	kg/h	kg/h	kg/h	kg/h	kg/h	kg/h	kg/h	kg/h	kg/h	kg/h	kg/h	kg/h	kg/h	kg/h	kg/h	
1,0	371	365	446	422	415	507	770	757	925	779	766	936	1143	1124	1372	1158	1139	1390	1591	1565	1910	1416	1392	1700	
2,0	592	582	711	675	664	811	1174	1154	1409	1187	1168	1426	1742	1713	2091	1765	1735	2119	2425	2384	2911	2299	2260	2760	
3,0	831	817	998	950	934	1141	1577	1551	1893	1596	1569	1916	2341	2302	2810	2371	2332	2847	3258	3204	3912	3279	3224	3937	
4,0	1044	1027	1253	1193	1173	1432	1981	1948	2378	2004	1970	2406	2940	2890	3529	2978	2928	3575	4092	4023	4912	4118	4049	4944	
5,0	1257	1236	1509	1436	1412	1724	2384	2344	2862	2412	2372	2896	3538	3479	4248	3584	3524	4303	4925	4843	5913	4957	4874	5951	
6,0	1469	1445	1764	1679	1651	2016	2788	2741	3347	2820	2773	3386	4137	4068	4967	4191	4121	5032	5759	5662	6914	5796	5699	6958	
7,0	1682	1654	2019	1922	1890	2308	3191	3138	3831	3229	3175	3876	4736	4657	5686	4798	4717	5760	6592	6482	7914	6635	6524	7966	
8,0	1895	1863	2275	2165	2129	2600	3594	3534	4315	3637	3576	4366	5335	5246	6405	5404	5314	6488	7426	7302	8915	7474	7349	8973	
9,0	2107	2072	2530	2408	2368	2891	3998	3931	4800	4045	3977	4856				6011	5910	7216	8259	8121	9916	8312	8174	9980	
10,0	2320	2281	2785	2651	2607	3183	4401	4328	5284	4453	4379	5346				6617	6507	7945	9093	8941	10916	9151	8998	1098	
15,0	3383	3327	4062	3866	3802	4642	6419	6311	7706	6494	6386	7797							13260	13038	15920	13346	13123		
20,0				5082	4997	6101				8535	8393	10247							17427	17136	20923	17540	17247		
25,0				6297	6192	7560				10576	10399	12698							21595	21234	25927	21734	21371		
30,0				7512	7386	9019				12617	12406	15148							25762	25332	30930	25929	25496		
35,0				8727	8581	10478																			
40,0				9942	9776	11937																			
45,0				11158	10971	13396																			
50,0				12373	12166	14854																			
55,0				13588	13361	16313																			
60,0				14803	14556	17772																			



Valvole di sicurezza scarico convogliato
Safety valves piped outlet

Calcolo portata di scarico valvola di sicurezza (ISO 4126-7 Ed.2013)
Safety Valve Fluid Delivery Calculation (ISO 4126-7 Ed.2013)

Tipo / Typ	D7/C						D10/C						G10						G14						G15								
	Fluido / Fluid	Aria / Air	Azoto / N2	CO2	Vapore saturo / Saturated steam	Acqua / H2O	Aria / Air	Azoto / N2	CO2	Vapore saturo / Saturated steam	Acqua / H2O	Aria / Air	Azoto / N2	CO2	Vapore saturo / Saturated steam	Acqua / H2O	Aria / Air	Azoto / N2	CO2	Vapore saturo / Saturated steam	Acqua / H2O	Aria / Air	Azoto / N2	CO2	Vapore saturo / Saturated steam	Acqua / H2O	Aria / Air	Azoto / N2	CO2	Vapore saturo / Saturated steam	Acqua / H2O		
PS (bar)	kg/h	kg/h	kg/h	kg/h	kg/h	kg/h	kg/h	kg/h	kg/h	kg/h	kg/h	kg/h	kg/h	kg/h	kg/h	kg/h	kg/h	kg/h	kg/h	kg/h	kg/h	kg/h	kg/h	kg/h	kg/h	kg/h	kg/h	kg/h	kg/h	kg/h	kg/h	kg/h	
1,0	60	59	73	37	703	114	112	137	71	1434	123	121	148	76	1434	214	210	257	132	2612	225	221	270	139	3228								
2,0	92	91	111	56	995	182	179	219	111	2028	188	185	225	114	2028	338	332	406	206	3694	343	337	412	209	4564								
3,0	124	122	149	75	1218	255	251	307	154	2483	252	248	303	152	2483	465	457	558	281	4524	461	453	554	278	5590								
4,0	155	153	187	93	1406	321	315	385	192	2868	317	312	380	190	2868	584	574	701	350	5224	579	569	695	347	6455								
5,0	187	184	225	112	1572	386	380	463	230	3206	381	375	458	228	3206	703	691	844	419	5841	697	685	837	416	7217								
6,0	219	215	263	130	1723	451	444	542	268	3512	446	439	535	265	3512	822	808	987	489	6398	815	801	978	484	7906								
7,0	250	246	301	148	1861	517	508	620	306	3794	511	502	613	302	3794	941	925	1130	557	6911	933	917	1120	552	8539								
8,0	282	277	339	167	1989	582	572	699	344	4056	575	566	691	340	4056	1060	1042	1273	626	7388	1051	1033	1262	621	9129								
9,0	314	308	377	185	2110	647	636	777	381	4302	640	629	768	377	4302	1179	1159	1416	694	7836	1169	1149	1403	688	9683								
10,0	345	340	415	203	2224	713	701	855	419	4534	704	692	846	414	4534	1298	1276	1558	763	8260	1287	1265	1545	757	10206								
15,0	504	495	605	294	2724	1039	1022	1248	607	5553	1027	1010	1233	600	5553	1893	1861	2273	1106	10116	1877	1845	2253	1096	12500								
20,0	662	651	795	386	3145	1366	1343	1640	795	6412	1350	1327	1621	786	6412	2488	2446	2987	1449	11681													
25,0	820	807	985	477	3516	1692	1664	2032	985	7169	1673	1645	2008	973	7169	3083	3031	3701	1794	13060													
30,0	979	962	1175		3852	2019	1985	2424		7853	1995	1962	2396		7853	3678	3616	4415		14306													
35,0	1137	1118	1365		4160	2345	2306	2816		8483					4273	4201	5130		15453														
40,0	1295	1274	1555		4448	2672	2627	3208		9068					4867	4786	5844		16519														
45,0	1454	1429	1745		4717	2999	2948	3600		9618					5462	5371	6558		17522														
50,0	1612	1585	1935		4973	3325	3270	3992		10139					6057	5956	7272		18469														
55,0	1770	1741	2125		5215	3652	3591	4384		10634					6652	6541	7987		19371														
60,0	1928	1896	2315		5447	3978	3912	4776		11106					7247	7126	8701		20232														

A richiesta siamo in grado eseguire calcoli specifici per altri gas, temperature e pressioni
On request we can perform specific calculations for other gases, temperatures and pressures

Valvole di sicurezza scarico convogliato - PVC
Safety valves piped outlet - PVC

Calcolo portata di scarico valvola di sicurezza (ISO 4126-7 Ed.2013)
Safety Valve Fluid Delivery Calculation (ISO 4126-7 Ed.2013)

Tipo / Typ	P10/A			P14/A		
Fluido / Fluid	Aria / Air	Azoto / N2	Acqua / H2O	Aria / Air	Azoto / N2	Acqua / H2O
PS (bar)	kg/h	kg/h	kg/h	kg/h	kg/h	kg/h
1	112	110	1434	220	216	2813
2	171	168	2028	335	330	3978
3	230	226	2483	451	443	4872
4	289	284	2868	566	557	5626
5	347	342	3206	681	670	6290
6	406	399	3512	797	783	6890
7	465	457	3794	912	897	7442
8	524	515	4056	1027	1010	7956
9	582	573	4302	1143	1124	8439
10	641	631	4534	1258	1237	8895
11	700	688	4756	1373	1350	9329
12	759	746	4967	1489	1464	9744
13	818	804	5170	1604	1577	10142
14	876	862	5365	1719	1691	10525
15	935	920	5553	1835	1804	10894
16	994	977	5735	1950	1917	11252



A richiesta siamo in grado eseguire calcoli specifici per altri gas, temperature e pressioni
On request we can perform specific calculations for other gases, temperatures and pressures

Tipo Tip	G20					G25					G32					B38/L					G40					
Fluido Fluid	Aria Air	Azoto N2	CO2 CO2	Vapore saturato Saturated steam	Acqua H2O	Aria Air	Azoto N2	CO2 CO2	Vapore saturato Saturated steam	Acqua H2O	Aria Air	Azoto N2	CO2 CO2	Vapore saturato Saturated steam	Acqua H2O	Aria Air	Azoto N2	CO2 CO2	Vapore saturato Saturated steam	Acqua H2O	Aria Air	Azoto N2	CO2 CO2	Vapore saturato Saturated steam	Acqua H2O	
PS (bar)	kg/h	kg/h	kg/h	kg/h	kg/h	kg/h	kg/h	kg/h	kg/h	kg/h	kg/h	kg/h	kg/h	kg/h	kg/h	kg/h	kg/h	kg/h	kg/h	kg/h	kg/h	kg/h	kg/h	kg/h	kg/h	kg/h
1,0	481	473	578	297	5735	707	695	849	436	8961	787	774	945	486	14682	1591	1565	1910	982	20705	1462	1438	1756	903	22952	
2,0	734	721	881	447	8111	1077	1059	1293	656	12673	1199	1179	1440	730	20763	2425	2384	2911	1477	29281	2370	2330	2845	1444	32460	
3,0	986	969	1183	595	9934	1447	1423	1738	874	15521	1611	1584	1934	973	25430	3258	3204	3912	1967	35861	3374	3318	4051	2037	39755	
4,0	1238	1217	1486	742	11471	1817	1787	2182	1090	17922	2023	1990	2429	1213	29364	4092	4023	4912	2454	41409	4237	4167	5087	2541	45905	
5,0	1490	1465	1789	889	12825	2188	2151	2627	1305	20037	2436	2395	2924	1453	32829	4925	4843	5913	2938	46297	5101	5015	6124	3043	51323	
6,0	1742	1713	2092	1035	14049	2558	2515	3071	1520	21950	2848	2800	3419	1692	35963	5759	5662	6914	3422	50716	5964	5864	7160	3544	56222	
7,0	1994	1961	2394	1181	15174	2928	2879	3516	1734	23709	3260	3205	3914	1930	38844	6592	6482	7914	3903	54779	6827	6713	8196	4043	60726	
8,0	2246	2209	2697	1326	16222	3298	3243	3960	1948	25346	3672	3611	4409	2168	41526	7426	7302	8915	4385	58562	7690	7562	9233	4541	64919	
9,0	2499	2457	3000	1472	17206	3669	3607	4405	2161	26883	4084	4016	4903	2406	44045	8259	8121	9916	4865	62114	8553	8410	10269	5038	68857	
10,0	2751	2705	3302	1617	18137	4039	3971	4849	2374	28337	4496	4421	5398	2643	46428	9093	8941	10916	5346	65474	9417	9259	11305	5536	72582	
15,0	4011	3944	4816	2343	22213	5890	5792	7071	3440	34706					13260	13038	15920	7744	80189							
20,0	5272	5184	6330	3070	25649	7741	7612	9294	4508	40075					17427	17136	20923	10150	92594							
25,0	6533	6424	7843	3802	28677	9592	9432	11516	5582	44805					21595	21234	25927	12566	103523							
30,0	7794	7663	9357		31414	11443	11252	13739		49082					25762	25332	30930		113404							
35,0	9054	8903	10871		33931	13295	13072	15961		53014																
40,0	10315	10143	12384		36274	15146	14893	18184		56675																
45,0	11576	11383	13898		38474	16997	16713	20406		60112																
50,0	12837	12622	15412		40555	18848	18533	22629		63364																
55,0	14097	13862	16925		42535	20699	20353	24851		66457																
60,0	15358	15102	18439		44426	22550	22174	27074		69412																



Valvole di sicurezza scarico convogliato (Alta pressione)
 Safety valves piped outlet (High pressure)

Calcolo portata di scarico valvola di sicurezza (ISO 4126-7 Ed.2013)
 Safety Valve Fluid Delivery Calculation (ISO 4126-7 Ed.2013)

Tipo / Typ	E10/L			E14/L		
	Aria Air	Azoto N2	CO2 CO2	Aria Air	Azoto N2	CO2 CO2
PS (bar)	kg/h	kg/h	kg/h	kg/h	kg/h	kg/h
1	125	123	150	245	241	294
2	190	187	228	373	367	448
3	255	251	307	501	493	601
4	321	315	385	629	619	755
5	386	380	463	757	745	909
6	451	444	542	885	871	1063
7	517	508	620	1013	997	1217
8	582	572	699	1142	1122	1371
9	647	636	777	1270	1248	1524
10	713	701	855	1398	1374	1678
15	1039	1022	1248	2039	2004	2447
20	1366	1343	1640	2679	2634	3217
25	1692	1664	2032	3320	3264	3986
30	2019	1985	2424	3961	3894	4755
35	2345	2306	2816	4601	4524	5524
40	2672	2627	3208	5242	5154	6293
45	2999	2948	3600	5883	5784	7063
50	3325	3270	3992	6523	6414	7832
55	3652	3591	4384	7164	7044	8601

Tipo / Typ	E10/L			E14/L		
	Aria Air	Azoto N2	CO2 CO2	Aria Air	Azoto N2	CO2 CO2
PS (bar)	kg/h	kg/h	kg/h	kg/h	kg/h	kg/h
60	3978	3912	4776	7805	7674	9370
65	4305	4233	5168	8445	8304	10139
70	4631	4554	5560	9086	8934	10908
75	4958	4875	5953	9727	9564	11678
80	5285	5196	6345	10367	10194	12447
85	5611	5517	6737	11008	10824	13216
90	5938	5839	7129	11649	11454	13985
95	6264	6160	7521	12289	12084	14754
100	6591	6481	7913	12930	12714	15524
105	6918	6802	8305	13571	13344	16293
110	7244	7123	8697	14211	13974	17062
115	7571	7444	9089	14852	14604	17831
120	7897	7765	9481	15493	15234	18600
125	8224	8086	9873	16133	15864	19370
130	8550	8408	10266	16774	16494	20139
135	8877	8729	10658	17415	17124	20908
140	9204	9050	11050	18055	17754	21677
145	9530	9371	11442	18696	18384	22446
150	9857	9692	11834	19337	19014	23215

A richiesta siamo in grado eseguire calcoli specifici per altri gas, temperature e pressioni
 On request we can perform specific calculations for other gases, temperatures and pressures



Valvole di sicurezza alla pressione

Safety valves High pressure

Calcolo portata di scarico valvola di sicurezza (ISO 4126-7 Ed.2013) Safety Valve Fluid Delivery Calculation (ISO 4126-7 Ed.2013)

Tipo / Typ	E5/LS	
Fluido / Fluid	Aria Air	Acqua H2O
PS (bar)	kg/h	kg/h
Temperatura °C	0	15
100	1584	3580
110	1741	3755
120	1898	3922
130	2055	4082
140	2212	4236
150	2369	4385
160	2526	4528
170	2683	4668
180	2841	4803
190	2998	4935
200	3155	5063
210	3312	5188
220	3469	5310
230	3626	5429
240	3783	5546
250	3940	5661
260	4097	5773
270	4254	5883
280	4411	5991
290	4568	6097
300	4725	6201
310	4882	6303
320	5039	6404
330	5196	6503
340	5353	6601
350	5510	6698
360	5667	6793
370	5824	6886
380	5981	6979
390	6138	7070
400	6295	7160
410	6452	7249
420	6609	7337
430	6766	7424
440	6923	7510
450	7080	7594
460	7237	7678
470	7394	7761
480	7551	7843
490	7708	7925
500	7865	8005
510	8022	8085
520	8179	8164
530	8336	8242
540	8493	8319
550	8650	8396
560	8807	8472
570	8964	8547
580	9121	8622
590	9278	8696
600	9435	8769

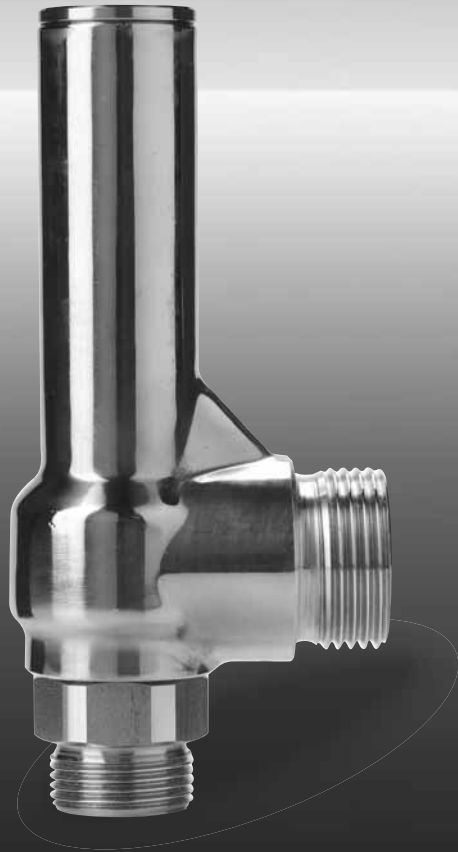

A richiesta siamo in grado eseguire calcoli specifici per altri gas, temperature e pressioni
 On request we can perform specific calculations for other gases, temperatures and pressures

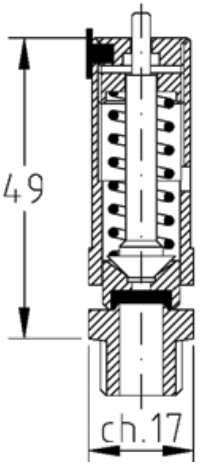
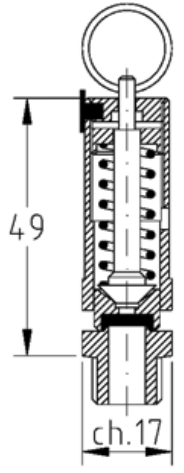
 <p>Z7 kg. 0,07</p>	Tipo / Type: Z7		do: 7 mm		
	Omologazione Homologation		PN	Coefficiente efflusso ridotto Low flow coefficient	Campo di taratura Setting range
	E.D. 2014/68/UE IV^ Cat.(PED)		16	0,72; >3 bar 0,82	0,3 - 16,0 bar
	EAC		16	0,72; >3 bar 0,82	0,3 - 16,0 bar
	ATEX Ex II 2 G c (1)		16	0,72; >3 bar 0,82	0,3 - 16,0 bar
	ATEX Ex II 2 D c		/	/	/
	ASME VIII Div.1		/	/	/
	Canadian Reg. CRN		/	/	/
 <p>Z7/A kg. 0,07</p>	CONFIGURAZIONE - CONFIGURATION				
	Materiale / Material		Ottone / Brass	Mista Ottone - Acciaio inox Mixed Brass - Stailnes steel	Acciaio inox Stailnes steel
	Modelli / Model		Senza ghiera Without ring nut	/	/
			Con anellino With ring	/	/
			/	/	/
			/	/	/
/			/	/	
Sedi di Tenuta Seal System		N.B.R. (Std) - 10 / + 100 °C E.P.D.M. - 50 / + 150 °C VITON - 20 / +200 °C SILICONE - 60 / +200 °C PTFE - 196 / +250 °C KALREZ - 20 / +250 °C /	/ / / / / /	/ / / / / /	
Connessione Entrata Inlet Connection		G.1/4" ISO228 / / / / /	/ / / / / /	/ / / / / /	
Connessione Uscita Outlet Connection		/ / / / / /	/ / / / / /	/ / / / / /	

Note: (1) No Modello Con protezione / No Model With Protection

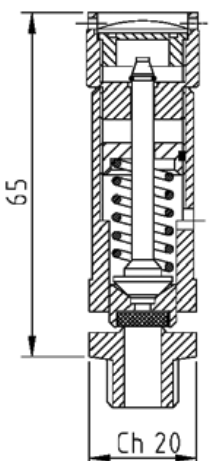
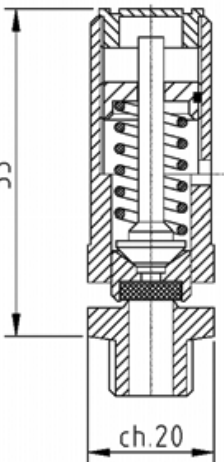
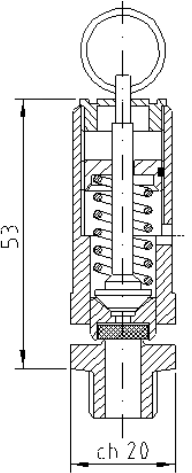
 <p>D7</p> <p>kg. 0,13</p>	Tipo / Type: D7		do: 7 mm		
	Omologazione Homologation		PN	Coefficiente efflusso ridotto Low flow coefficient	Campo di taratura Setting range
	E.D. 2014/68/UE IV^ Cat.(PED)		60	0,81	0,3 - 60,0 bar
	EAC		60	0,81	0,3 - 60,0 bar
	ATEX Ex II 2 G c (1)		60	0,81	0,3 - 60,0 bar
	ATEX Ex II 2 D c		/	/	/
	ASME VIII Div.1		40	0,712	1,0 - 40,0 bar
	Canadian Reg. CRN		40	0,712	1,0 - 40,0 bar
 <p>D7/S</p> <p>kg. 0,10</p>	CONFIGURAZIONE - CONFIGURATION				
	Materiale / Material		Ottone / Brass	Mista Ottone - Acciaio inox Mixed Brass - Stainless steel	Acciaio inox Stainless steel
	Modelli / Model		Con ghiera With ring nut	/	Con ghiera Without ring nut
			Senza ghiera Without ring nut	/	Senza ghiera Without ring nut
			Con anellino With ring	/	Con anellino With ring
			/	/	/
/			/	/	
 <p>D7/A</p> <p>kg. 0,12</p>	Sedi di Tenuta Seal System		N.B.R. (Std) - 10 / + 100 °C E.P.D.M. - 50 / + 150 °C VITON - 20 / +200 °C SILICONE - 60 / +200 °C PTFE - 196 / +250 °C KALREZ - 20 / +250 °C /	/ / / / / / /	N.B.R. (Std) - 10 / + 100 °C E.P.D.M. - 50 / + 150 °C VITON - 20 / +200 °C SILICONE - 60 / +200 °C PTFE - 196 / +250 °C KALREZ - 20 / +275 °C /
	Connessione Entrata Inlet Connection		G.1/4" - 3/8" ISO228 R.1/4" - 3/8" EN10226 1/4" - 3/8" NPT / / / /	/ / / / / /	G.1/4" - 3/8" ISO228 R.1/4" - 3/8" EN10226 1/4" - 3/8" NPT / / / /
	Connessione Uscita Outlet Connection		/ / / / / /	/ / / / / /	/ / / / / /

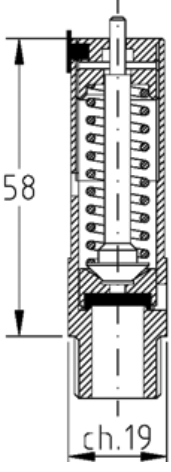
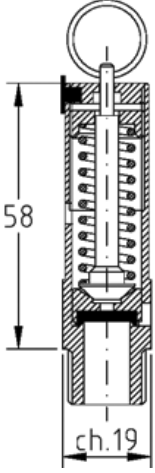
 <p>Z10 kg. 0,09</p>	Tipo / Type: Z10		do: 10 mm		
	Omologazione Homologation		PN	Coefficiente efflusso ridotto Low flow coefficient	Campo di taratura Setting range
	E.D. 2014/68/UE IV^ Cat.(PED)		16	0,72; >3 bar 0,82	0,3 - 16,0 bar
	EAC		16	0,72; >3 bar 0,82	0,3 - 16,0 bar
	ATEX Ex II 2 G c (1)		16	0,72; >3 bar 0,82	0,3 - 16,0 bar
	ATEX Ex II 2 D c		/	/	/
	ASME VIII Div.1		/	/	/
	Canadian Reg. CRN		/	/	/
 <p>Z10/A kg. 0,09</p>	CONFIGURAZIONE - CONFIGURATION				
	Materiale / Material		Ottone / Brass	Mista Ottone - Acciaio inox Mixed Brass - Stailnes steel	Acciaio inox Stailnes steel
	Modelli / Model		Senza ghiera Without ring nut	/	/
			Con anellino With ring	/	/
			/	/	/
			/	/	/
/			/	/	
Sedi di Tenuta Seal System		N.B.R. (Std) - 10 / + 100 °C E.P.D.M. - 50 / + 150 °C VITON - 20 / +200 °C SILICONE - 60 / +200 °C PTFE - 196 / +250 °C KALREZ - 20 / +250 °C /	/ / / / / /	/ / / / / /	
Connessione Entrata Inlet Connection		G.3/8" ISO228 / / / / /	/ / / / / /	/ / / / / /	
Connessione Uscita Outlet Connection		/ / / / / /	/ / / / / /	/ / / / / /	

Note: (1) No Modello Con protezione / No Model With Protection

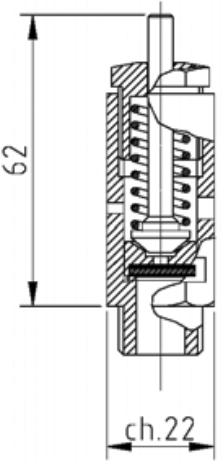
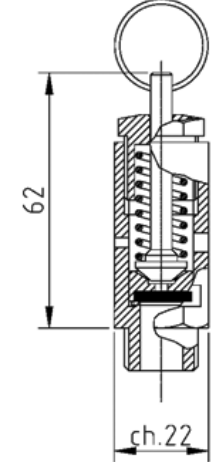
 <p>C10 kg. 0,11</p>	Tipo / Type: C10		do: 10 mm		
	Omologazione Homologation		PN	Coefficiente efflusso ridotto Low flow coefficient	Campo di taratura Setting range
	E.D. 2014/68/UE IV^ Cat.(PED)		16	0,69	0,3 - 16,0 bar
	EAC		16	0,69	0,3 - 16,0 bar
	ATEX Ex II 2 G c (1)		16	0,69	0,3 - 16,0 bar
	ATEX Ex II 2 D c		/	/	/
	ASME VIII Div.1		16	0,712	1,0 - 16,0 bar
	Canadian Reg. CRN		16	0,712	1,0 - 16,0 bar
 <p>C10/A kg. 0,11</p>	CONFIGURAZIONE - CONFIGURATION				
	Materiale / Material		Ottone / Brass	Mista Ottone - Acciaio inox Mixed Brass - Stailnes steel	Acciaio inox Stailnes steel
	Modelli / Model		Con ghiera With ring nut	/	Con ghiera Without ring nut
			Con anellino With ring	/	Con anellino With ring
			/	/	/
			/	/	/
/			/	/	
Sedi di Tenuta Seal System		N.B.R. (Std) - 10 / + 100 °C	/	N.B.R. (Std) - 10 / + 100 °C	
		E.P.D.M. - 50 / + 150 °C	/	E.P.D.M. - 50 / + 150 °C	
		VITON - 20 / +200 °C	/	VITON - 20 / +200 °C	
		SILICONE - 60 / +200 °C	/	SILICONE - 60 / +200 °C	
		PTFE - 196 / +250 °C	/	PTFE - 196 / +250 °C	
		KALREZ - 20 / +250 °C	/	KALREZ - 20 / +275 °C	
		/	/	/	
Connessione Entrata Inlet Connection		G.3/8" - 1/2" ISO228	/	G.3/8" - 1/2" ISO228	
		R.3/8" - 1/2" EN10226	/	R.3/8" - 1/2" EN10226	
		3/8" - 1/2" NPT	/	3/8" - 1/2" NPT	
		/	/	3/4" Tri Clamp	
		/	/	/	
		/	/	/	
Connessione Uscita Outlet Connection		/	/	/	
		/	/	/	
		/	/	/	
		/	/	/	
		/	/	/	
		/	/	/	

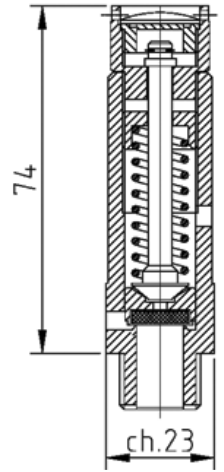
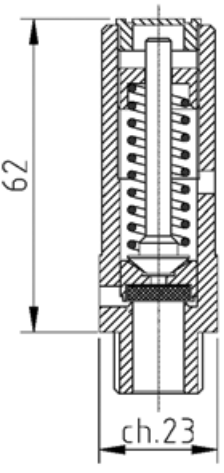
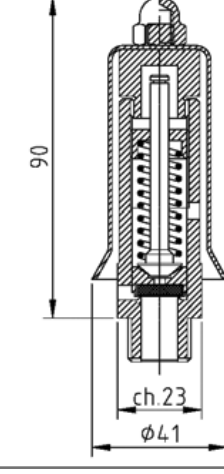
 <p>D10 kg. 0,20</p>	Tipo / Type: D10		do: 10 mm		
	Omologazione Homologation		PN	Coefficiente efflusso ridotto Low flow coefficient	Campo di taratura Setting range
	E.D. 2014/68/UE IV^ Cat.(PED)		60	0,77	0,3 - 60,0 bar
	EAC		60	0,77	0,3 - 60,0 bar
	ATEX Ex II 2 G c (1)		60	0,77	0,3 - 60,0 bar
	ATEX Ex II 2 D c		/	/	/
	ASME VIII Div.1		40	0,712	1,0 - 40,0 bar
	Canadian Reg. CRN		40	0,712	1,0 - 40,0 bar
 <p>D10/S kg. 0,18</p>	CONFIGURAZIONE - CONFIGURATION				
	Materiale / Material		Ottone / Brass	Mista Ottone - Acciaio inox Mixed Brass - Stailnes steel	Acciaio inox Stailnes steel
	Modelli / Model		Con ghiera With ring nut	/	Con ghiera Without ring nut
			Senza ghiera Without ring nut	/	Senza ghiera Without ring nut
			Con protezione With protection	/	Con protezione With protection
			/	/	/
/			/	/	
 <p>D10/P kg. 0,22</p>	Sedi di Tenuta Seal System		N.B.R. (Std) - 10 / + 100 °C E.P.D.M. - 50 / + 150 °C VITON - 20 / +200 °C SILICONE - 60 / +200 °C PTFE - 196 / +250 °C KALREZ - 20 / +250 °C /	/ / / / / / /	N.B.R. (Std) - 10 / + 100 °C E.P.D.M. - 50 / + 150 °C VITON - 20 / +200 °C SILICONE - 60 / +200 °C PTFE - 196 / +250 °C KALREZ - 20 / +275 °C /
	Connessione Entrata Inlet Connection		G.3/8" - 1/2" ISO228 R.3/8" - 1/2" EN10226 3/8" - 1/2" NPT / / /	/ / / / /	G.3/8" - 1/2" ISO228 R.3/8" - 1/2" EN10226 3/8" - 1/2" NPT 3/4" Tri Clamp / / /
	Connessione Uscita Outlet Connection		/ / / / / /	/ / / / / /	/ / / / / /

Note: (1) No Modello Con protezione / No Model With Protection

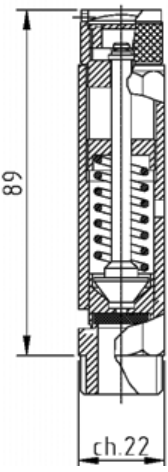
 <p>B12</p> <p>kg. 0,24</p>	Tipo: / Type: B12		do: 12 mm		
	Omologazione Homologation		PN	Coefficiente efflusso ridotto Low flow coefficient	Campo di taratura Setting range
	E.D. 2014/68/UE IV^ Cat.(PED)		40	0,75	0,3 - 30,0 bar
	EAC		40	0,75	0,3 - 30,0 bar
	ATEX Ex II 2 G c (1)		40	0,75	0,3 - 30,0 bar
	ATEX Ex II 2 D c		/	/	/
	ASME VIII Div.1		40	0,712	1,0 - 30,0 bar
	Canadian Reg. CRN		40	0,712	1,0 - 30,0 bar
CONFIGURAZIONE - CONFIGURATION					
Materiale / Material		Ottone / Brass	Mista Ottone - Acciaio inox Mixed Brass - Stailnes steel	Acciaio inox Stailnes steel	
Modelli / Model		Con ghiera With ring nut	/	/	
		/	/	/	
		/	/	/	
		/	/	/	
		/	/	/	
		/	/	/	
Sedi di Tenuta Seal System		N.B.R. (Std) - 10 / + 100 °C	/	/	
		E.P.D.M. - 50 / + 150 °C	/	/	
		VITON - 20 / +200 °C	/	/	
		SILICONE - 60 / +200 °C	/	/	
		PTFE - 196 / +250 °C	/	/	
		KALREZ - 20 / +250 °C	/	/	
		/	/	/	
Connessione Entrata Inlet Connection		G.1/2" ISO228	/	/	
		R.1/2" EN10226	/	/	
		1/2" NPT	/	/	
		/	/	/	
		/	/	/	
		/	/	/	
Connessione Uscita Outlet Connection		/	/	/	
		/	/	/	
		/	/	/	
		/	/	/	
		/	/	/	
		/	/	/	

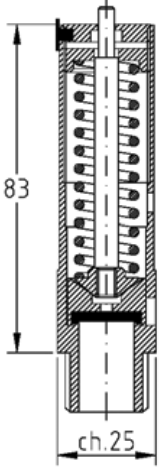
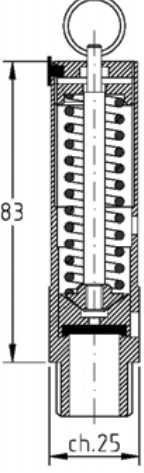
 <p>Z14 kg. 0,20</p>	Tipo / Type: Z14		do: 14 mm		
	Omologazione Homologation		PN	Coefficiente efflusso ridotto Low flow coefficient	Campo di taratura Setting range
	E.D. 2014/68/UE IV^ Cat.(PED)		16	0,72; >3 bar 0,82	0,3 - 16,0 bar
	EAC		16	0,72; >3 bar 0,82	0,3 - 16,0 bar
	ATEX Ex II 2 G c (1)		16	0,72; >3 bar 0,82	0,3 - 16,0 bar
	ATEX Ex II 2 D c		/	/	/
	ASME VIII Div.1		/	/	/
	Canadian Reg. CRN		/	/	/
 <p>Z14/A kg. 0,20</p>	CONFIGURAZIONE - CONFIGURATION				
	Materiale / Material	Ottone / Brass	Mista Ottone - Acciaio inox Mixed Brass - Stailnes steel	Acciaio inox Stailnes steel	
	Modelli / Model	Senza ghiera Without ring nut	/	/	/
		Con anellino With ring	/	/	/
		/	/	/	/
		/	/	/	/
/		/	/	/	
Sedi di Tenuta Seal System	N.B.R. (Std) - 10 / + 100 °C	/	/	/	
	E.P.D.M. - 50 / + 150 °C	/	/	/	
	VITON - 20 / +200 °C	/	/	/	
	SILICONE - 60 / +200 °C	/	/	/	
	PTFE - 196 / +250 °C	/	/	/	
	KALREZ - 20 / +250 °C	/	/	/	
	/	/	/	/	
Connessione Entrata Inlet Connection	G.1/2" ISO228	/	/	/	
	/	/	/	/	
	/	/	/	/	
	/	/	/	/	
	/	/	/	/	
	/	/	/	/	
Connessione Uscita Outlet Connection	/	/	/	/	
	/	/	/	/	
	/	/	/	/	
	/	/	/	/	
	/	/	/	/	
	/	/	/	/	

Note: (1) No Modello Con protezione / No Model With Protection

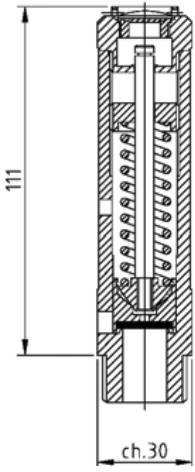
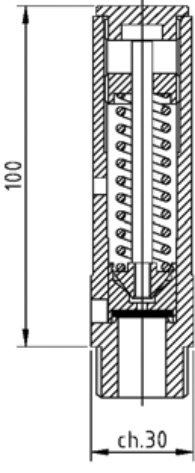
 <p>D14</p> <p>kg. 0,50</p>	Tipo: / Type: D14		do: 14 mm		
	Omologazione Homologation		PN	Coefficiente efflusso ridotto Low flow coefficient	Campo di taratura Setting range
	E.D. 2014/68/UE IV^ Cat.(PED)		40	0,72; >3 bar 0,81	0,3 - 30,0 bar
	EAC		40	0,72; >3 bar 0,81	0,3 - 30,0 bar
	ATEX Ex II 2 G c (1)		40	0,72; >3 bar 0,81	0,3 - 30,0 bar
	ATEX Ex II 2 D c		/	/	/
	ASME VIII Div.1		60	0,712	1,0 - 44,0 bar
	Canadian Reg. CRN		60	0,712	1,0 - 44,0 bar
 <p>D14/S</p> <p>kg. 0,47</p>	CONFIGURAZIONE - CONFIGURATION				
	Materiale / Material		Ottone / Brass	Mista Ottone - Acciaio inox Mixed Brass - Stailnes steel	Acciaio inox Stailnes steel
	Modelli / Model		Con ghiera With ring nut	/	Con ghiera With ring nut
			Senza ghiera Without ring nut	/	Senza ghiera Without ring nut
			Con protezione With protection	/	Con protezione With protection
			/	/	/
/			/	/	
Sedi di Tenuta Seal System		N.B.R. (Std) - 10 / + 100 °C E.P.D.M. - 50 / + 150 °C VITON - 20 / +200 °C SILICONE - 60 / +200 °C PTFE - 196 / +250 °C KALREZ - 20 / +250 °C /	/ / / / / /	N.B.R. (Std) - 10 / + 100 °C E.P.D.M. - 50 / + 150 °C VITON - 20 / +200 °C SILICONE - 60 / +200 °C PTFE - 196 / +250 °C KALREZ - 20 / +275 °C /	
Connessione Entrata Inlet Connection		G.1/2" - 3/4" ISO228 R.1/2" - 3/4" EN10226 1/2" - 3/4" NPT / / /	/ / / / /	G.1/2" - 3/4" ISO228 R.1/2" - 3/4" EN10226 1/2" - 3/4" NPT 3/4" - 1"1/2 Tri Clamp / / /	
Connessione Uscita Outlet Connection		/ / / / / /	/ / / / /	/ / / / /	

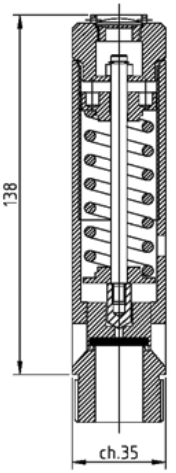
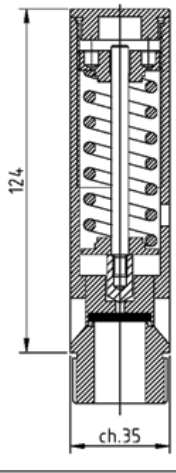
 <p>F18 kg. 0,75</p>	Tipo / Type: F18		do: 18 mm		
	Omologazione Homologation		PN	Coefficiente efflusso ridotto Low flow coefficient	Campo di taratura Setting range
	E.D. 2014/68/UE IV^ Cat.(PED)		40	0,74; >3 bar 0,84	0,3 - 21,0 bar
	EAC		40	0,74; >3 bar 0,84	0,3 - 21,0 bar
	ATEX Ex II 2 G c (1)		40	0,74; >3 bar 0,84	0,3 - 21,0 bar
	ATEX Ex II 2 D c		/	/	/
	ASME VIII Div.1		40	0,712	1,0 - 21,0 bar
	Canadian Reg. CRN		40	0,712	1,0 - 21,0 bar
 <p>F18/S kg. 0,68</p>	CONFIGURAZIONE - CONFIGURATION				
	Materiale / Material		Ottone / Brass	Mista Ottone - Acciaio inox Mixed Brass - Stainless steel	Acciaio inox Stainless steel
	Modelli / Model		Con ghiera With ring nut	/	/
			Senza ghiera Without ring nut	/	/
			Con protezione With protection	/	/
			/	/	/
/			/	/	
Sedi di Tenuta Seal System		N.B.R. (Std) - 10 / + 100 °C	/	/	
		E.P.D.M. - 50 / + 150 °C	/	/	
		VITON - 20 / +200 °C	/	/	
		SILICONE - 60 / +200 °C	/	/	
		PTFE - 196 / +250 °C	/	/	
		KALREZ - 20 / +250 °C	/	/	
		/	/	/	
Connessione Entrata Inlet Connection		G.1" ISO228	/	/	
		R.1" EN10226	/	/	
		1" NPT	/	/	
		/	/	/	
		/	/	/	
		/	/	/	
Connessione Uscita Outlet Connection		/	/	/	
		/	/	/	
		/	/	/	
		/	/	/	
		/	/	/	
		/	/	/	

Note: (1) No Modello Con protezione / No Model With Protection

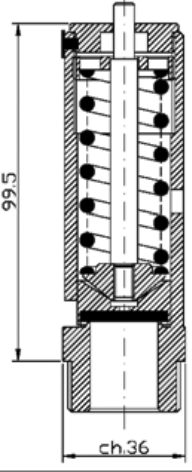
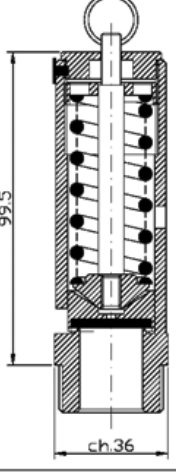
 <p>Z20 kg. 0,51</p>	Tipo: / Type: Z20		do: 20 mm		
	Omologazione Homologation		PN	Coefficiente efflusso ridotto Low flow coefficient	Campo di taratura Setting range
	E.D. 2014/68/UE IV^ Cat.(PED)		16	0,62; >3 bar 0,7	0,3 - 16,0 bar
	EAC		16	0,62; >3 bar 0,7	0,3 - 16,0 bar
	ATEX Ex II 2 G c (1)		16	0,62; >3 bar 0,7	0,3 - 16,0 bar
	ATEX Ex II 2 D c		/	/	/
	ASME VIII Div.1		/	/	/
	Canadian Reg. CRN		/	/	/
 <p>Z20/A kg. 0,51</p>	CONFIGURAZIONE - CONFIGURATION				
	Materiale / Material	Ottone / Brass	Mista Ottone - Acciaio inox Mixed Brass - Stailnes steel	Acciaio inox Stailnes steel	
	Modelli / Model	Senza ghiera Without ring nut	/ /	/ /	/ /
		Con anellino With ring	/ /	/ /	/ /
		/ /	/ /	/ /	/ /
		/ /	/ /	/ /	/ /
/ /		/ /	/ /	/ /	
Sedi di Tenuta Seal System	N.B.R. (Std) - 10 / + 100 °C	/	/		
	E.P.D.M. - 50 / + 150 °C	/	/		
	VITON - 20 / +200 °C	/	/		
	SILICONE - 60 / +200 °C	/	/		
	PTFE - 196 / +250 °C	/	/		
	KALREZ - 20 / +250 °C	/	/		
	/	/	/		
Connessione Entrata Inlet Connection	G.1" ISO228	/	/		
	/	/	/		
	/	/	/		
	/	/	/		
	/	/	/		
	/	/	/		
	/	/	/		
Connessione Uscita Outlet Connection	/	/	/		
	/	/	/		
	/	/	/		
	/	/	/		
	/	/	/		
	/	/	/		
	/	/	/		

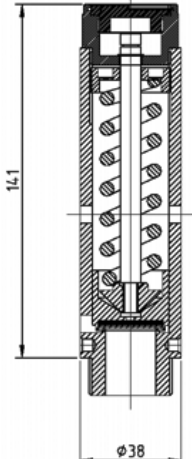
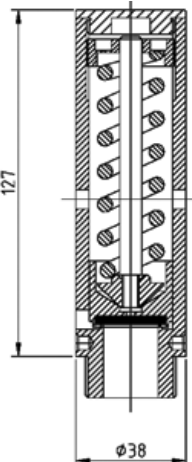
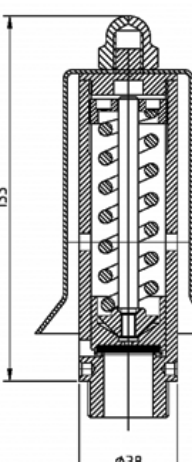
 <p>B20 kg. 0,97</p>	Tipo / Type: B20		do: 20 mm		
	Omologazione Homologation		PN	Coefficiente efflusso ridotto Low flow coefficient	Campo di taratura Setting range
	E.D. 2014/68/UE IV^A Cat.(PED)		60	0,71; >3 bar 0,8	0,3 - 60,0 bar
	EAC		60	0,71; >3 bar 0,8	0,3 - 60,0 bar
	ATEX Ex II 2 G c (1)		60	0,71; >3 bar 0,8	0,3 - 60,0 bar
	ATEX Ex II 2 D c		/	/	/
	ASME VIII Div.1		40	0,712	1,0 - 35,0 bar
Canadian Reg. CRN		40	0,712	1,0 - 35,0 bar	
 <p>B20/S kg. 0,89</p>	CONFIGURAZIONE - CONFIGURATION				
	Materiale / Material		Ottone / Brass	Mista Ottone - Acciaio inox Mixed Brass - Stainless steel	Acciaio inox Stainless steel
	Modelli / Model		Con ghiera With ring nut	Con ghiera With ring nut	Con ghiera With ring nut
			Senza ghiera Without ring nut	Senza ghiera Without ring nut	Senza ghiera Without ring nut
			Con protezione With protection	Con protezione With protection	Con protezione With protection
/ /			/ /	/ /	
		/ /	/ /	/ /	
 <p>B20/P kg. 0,98</p>	Sedi di Tenuta Seal System		N.B.R. (Std) - 10 / +100 °C E.P.D.M. - 50 / +150 °C VITON - 20 / +200 °C SILICONE - 60 / +200 °C PTFE - 196 / +250 °C KALREZ - 20 / +250 °C /	N.B.R. (Std) - 10 / +100 °C E.P.D.M. - 50 / +150 °C VITON - 20 / +200 °C SILICONE - 60 / +200 °C PTFE - 196 / +250 °C KALREZ - 20 / +250 °C METAL - 196 / +250 °C	N.B.R. (Std) - 10 / +100 °C E.P.D.M. - 50 / +150 °C VITON - 20 / +200 °C SILICONE - 60 / +200 °C PTFE - 196 / +250 °C KALREZ - 20 / +275 °C METAL - 196 / +450 °C
	Connessione Entrata Inlet Connection		G.1" ISO228 R.1" EN10226 1" NPT DN25 PN16 - 40 - 60 1" 150 - 300 lb / /	G.1" ISO228 R.1" EN10226 1" NPT 1" - 1"1/2 Tri Clamp DN25 DIN405 - 11851 DN25 PN16 - 40 - 60 1" 150 - 300 lb	G.1" ISO228 R.1" EN10226 1" NPT 1" - 1"1/2 Tri Clamp DN25 DIN405 - 11851 DN25 PN16 - 40 - 60 1" 150 - 300 lb
	Connessione Uscita Outlet Connection		/ / / / / /	/ / / / / /	/ / / / / /
			/ / / / / /	/ / / / / /	/ / / / / /

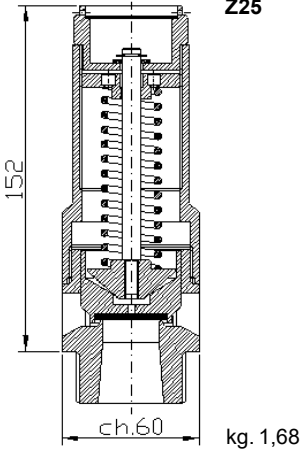
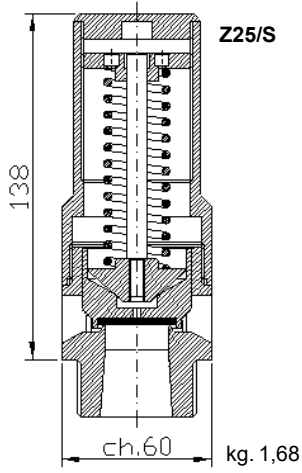
 <p>Z25 kg. 1,68</p>	Tipo / Type: Z25		do: 25 mm		
	Omologazione Homologation		PN	Coefficiente efflusso ridotto Low flow coefficient	Campo di taratura Setting range
	E.D. 2014/68/UE IV^A Cat.(PED)		16	0,85	0,3 - 16,0 bar
	EAC		16	0,85	0,3 - 16,0 bar
	ATEX Ex II 2 G c (1)		16	0,85	0,3 - 16,0 bar
	ATEX Ex II 2 D c		/	/	/
	ASME VIII Div.1		/	/	/
	Canadian Reg. CRN		/	/	/
 <p>Z25/S kg. 1,68</p>	CONFIGURAZIONE - CONFIGURATION				
	Materiale / Material		Ottone / Brass	Mista Ottone - Acciaio inox Mixed Brass - Stainless steel	Acciaio inox Stainless steel
	Modelli / Model		Con ghiera With ring nut	/	/
			Senza ghiera Without ring nut	/	/
			/	/	/
			/	/	/
/			/	/	
Sedi di Tenuta Seal System		N.B.R. (Std) - 10 / + 100 °C	/	/	
		E.P.D.M. - 50 / + 150 °C	/	/	
		VITON - 20 / +200 °C	/	/	
		SILICONE - 60 / +200 °C	/	/	
		PTFE - 196 / +250 °C	/	/	
		KALREZ - 20 / +250 °C	/	/	
		/	/	/	
Connessione Entrata Inlet Connection		G.1"1/4 - 1"1/2 ISO228	/	/	
		R.1"1/4 - 1"1/2 EN10226	/	/	
		1"1/4 - 1"1/2 NPT	/	/	
		DN32 - 40 PN16	/	/	
		1"1/4 - 1"1/2 150 lb	/	/	
		/	/	/	
		/	/	/	
Connessione Uscita Outlet Connection		/	/	/	
		/	/	/	
		/	/	/	
		/	/	/	
		/	/	/	
		/	/	/	

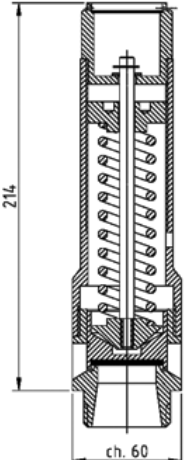
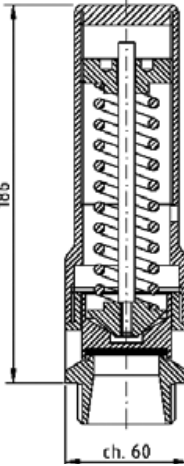
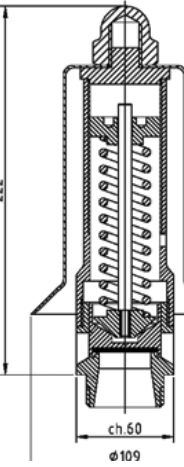
 <p>F25 kg. 2,03</p>	Tipo / Type: F25		do: 25 mm		
	Omologazione Homologation		PN	Coefficiente efflusso ridotto Low flow coefficient	Campo di taratura Setting range
	E.D. 2014/68/UE IV^ Cat.(PED)		40	0,86	0,3 - 30,0 bar
	EAC		40	0,86	0,3 - 30,0 bar
	ATEX Ex II 2 G c (1)		40	0,86	0,3 - 30,0 bar
	ATEX Ex II 2 D c		/	/	/
	ASME VIII Div.1		40	0,712	1,0 - 30,0 bar
	Canadian Reg. CRN		40	0,712	1,0 - 30,0 bar
 <p>F25/S kg. 2,00</p>	CONFIGURAZIONE - CONFIGURATION				
	Materiale / Material		Ottone / Brass	Mista Ottone - Acciaio inox Mixed Brass - Stainless steel	Acciaio inox Stainless steel
	Modelli / Model		Con ghiera With ring nut	Con ghiera With ring nut	Con ghiera With ring nut
			Senza ghiera Without ring nut	Senza ghiera Without ring nut	Senza ghiera Without ring nut
			Con protezione With protection	Con protezione With protection	Con protezione With protection
			/ /	/ /	/ /
		/ /	/ /	/ /	
 <p>F25/P kg. 2,37</p>	Sedi di Tenuta Seal System		N.B.R. (Std) - 10 / + 100 °C E.P.D.M. - 50 / + 150 °C VITON - 20 / +200 °C SILICONE - 60 / +200 °C PTFE - 196 / +250 °C KALREZ - 20 / +250 °C /	N.B.R. (Std) - 10 / + 100 °C E.P.D.M. - 50 / + 150 °C VITON - 20 / +200 °C SILICONE - 60 / +200 °C PTFE - 196 / +250 °C KALREZ - 20 / +250 °C METAL - 196 / +250 °C	N.B.R. (Std) - 10 / + 100 °C E.P.D.M. - 50 / + 150 °C VITON - 20 / +200 °C SILICONE - 60 / +200 °C PTFE - 196 / +250 °C KALREZ - 20 / +275 °C METAL - 196 / +450 °C
	Connessione Entrata Inlet Connection		G.1"1/4 - 1"1/2 ISO228 R.1"1/4 - 1"1/2 EN10226 1"1/4 - 1"1/2 NPT DN32 - 40 PN16 - 40 1"1/4 - 1"1/2 150 - 300 lb / /	G.1"1/4 - 1"1/2 ISO228 R.1"1/4 - 1"1/2 EN10226 1"1/4 - 1"1/2 NPT 1"1/2 Tri Clamp DN25 - 32 - 40 DIN405 -11851 DN32 - 40 PN16 - 40 1"1/4 - 1"1/2 150 - 300 lb	G.1"1/4 - 1"1/2 ISO228 R.1"1/4 - 1"1/2 EN10226 1"1/4 - 1"1/2 NPT 1"1/2 Tri Clamp DN25 - 32 - 40 DIN405 - 11851 DN32 - 40 PN16 - 40 1"1/4 - 1"1/2 150 - 300 lb
	Connessione Uscita Outlet Connection		/ / / / / /	/ / / / / /	/ / / / / /
			/ / / / / /	/ / / / / /	/ / / / / /

Note: (1) No Modello Con protezione / No Model With Protection

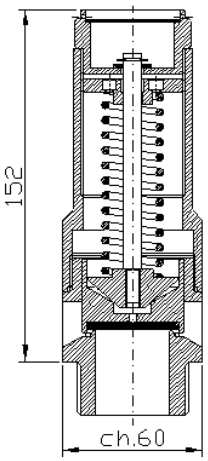
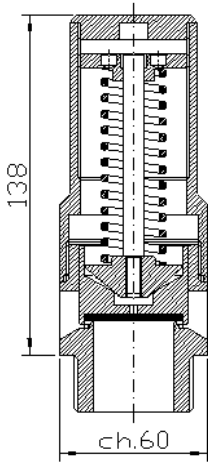
 <p>Z32 kg. 1,70</p>	Tipo / Type: Z32		do: 32 mm		
	Omologazione Homologation		PN	Coefficiente efflusso ridotto Low flow coefficient	Campo di taratura Setting range
	E.D. 2014/68/UE IV^A Cat.(PED)		16	0,73	0,3 - 8,0 bar
	EAC		16	0,73	0,3 - 8,0 bar
	ATEX Ex II 2 G c (1)		16	0,73	0,3 - 8,0 bar
	ATEX Ex II 2 D c		/	/	/
	ASME VIII Div.1		/	/	/
	Canadian Reg. CRN		/	/	/
 <p>Z32/S kg. 1,70</p>	CONFIGURAZIONE - CONFIGURATION				
	Materiale / Material	Ottone / Brass	Mista Ottone - Acciaio inox Mixed Brass - Stailnes steel	Acciaio inox Stailnes steel	
	Modelli / Model	Con ghiera With ring nut	/	/	/
		Senza ghiera Without ring nut	/	/	/
		/	/	/	/
		/	/	/	/
/		/	/	/	
Sedi di Tenuta Seal System	N.B.R. (Std) - 10 / + 100 °C	/	/	/	
	E.P.D.M. - 50 / + 150 °C	/	/	/	
	VITON - 20 / +200 °C	/	/	/	
	SILICONE - 60 / +200 °C	/	/	/	
	PTFE - 196 / +250 °C	/	/	/	
	KALREZ - 20 / +250 °C	/	/	/	
	/	/	/	/	
Connessione Entrata Inlet Connection	G.1"1/2 ISO228	/	/	/	
	R.1"1/2 EN10226	/	/	/	
	1"1/2 NPT	/	/	/	
	DN40 PN16	/	/	/	
	1"1/2 150 lb	/	/	/	
	/	/	/	/	
	/	/	/	/	
Connessione Uscita Outlet Connection	/	/	/	/	
	/	/	/	/	
	/	/	/	/	
	/	/	/	/	
	/	/	/	/	
	/	/	/	/	
	/	/	/	/	

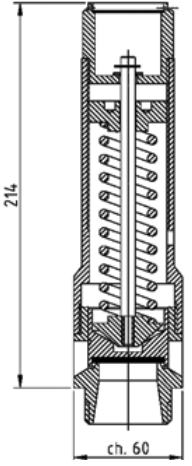
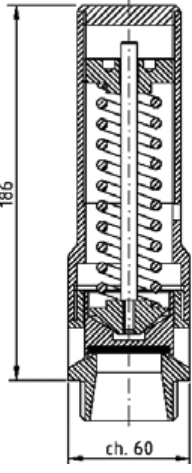
 <p>F32 kg. 2,50</p>	Tipo / Type: F32		do: 32 mm		
	Omologazione Homologation		PN	Coefficiente efflusso ridotto Low flow coefficient	Campo di taratura Setting range
	E.D. 2014/68/UE IV^ Cat.(PED)		40	0,78	0,3 - 14,0 bar
	EAC		40	0,78	0,3 - 14,0 bar
	ATEX Ex II 2 G c (1)		40	0,78	0,3 - 14,0 bar
	ATEX Ex II 2 D c		/	/	/
	ASME VIII Div.1		40	0,712	1,0 - 12,2 bar
	Canadian Reg. CRN		40	0,712	1,0 - 12,2 bar
 <p>F32/S kg. 2,50</p>	CONFIGURAZIONE - CONFIGURATION				
	Materiale / Material		Ottone / Brass	Mista Ottone - Acciaio inox Mixed Brass - Stainless steel	Acciaio inox Stainless steel
	Modelli / Model		Con ghiera With ring nut	Con ghiera With ring nut	Con ghiera With ring nut
			Senza ghiera Without ring nut	Senza ghiera Without ring nut	Senza ghiera Without ring nut
			Con protezione With protection	Con protezione With protection	Con protezione With protection
			/	/	/
			/	/	/
	Sedi di Tenuta Seal System		N.B.R. (Std) - 10 / + 100 °C E.P.D.M. - 50 / + 150 °C VITON - 20 / +200 °C SILICONE - 60 / +200 °C PTFE - 196 / +250 °C KALREZ - 20 / +250 °C /	N.B.R. (Std) - 10 / + 100 °C E.P.D.M. - 50 / + 150 °C VITON - 20 / +200 °C SILICONE - 60 / +200 °C PTFE - 196 / +250 °C KALREZ - 20 / +250 °C METAL - 196 / +250 °C	N.B.R. (Std) - 10 / + 100 °C E.P.D.M. - 50 / + 150 °C VITON - 20 / +200 °C SILICONE - 60 / +200 °C PTFE - 196 / +250 °C KALREZ - 20 / +275 °C METAL - 196 / +450 °C
Connessione Entrata Inlet Connection		G.1"1/2 ISO228 R.1"1/2 EN10226 1"1/2 NPT DN40 PN16 - 40 1"1/2 150 - 300 lb / /	G.1"1/2 ISO228 R.1"1/2 EN10226 1"1/2 NPT 1"1/2 - 2" Tri Clamp DN32 - 32 - 40 DIN405 - 11851 DN40 PN16 - 40 1"1/2 150 - 300 lb	G.1"1/2 ISO228 R.1"1/2 EN10226 1"1/2 NPT 1"1/2 - 2" Tri Clamp DN32 - 32 - 40 DIN405 - 11851 DN40 PN16 - 40 1"1/2 150 - 300 lb	
Connessione Uscita Outlet Connection		/	/	/	

Note: (1) No Modello Con protezione / No Model With Protection

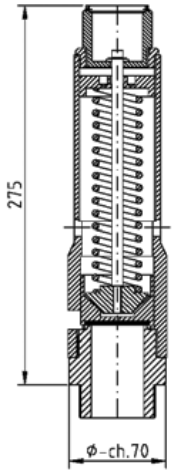
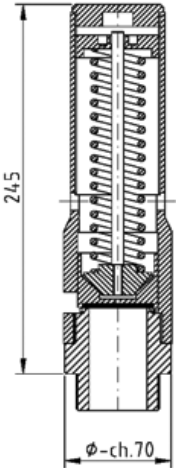
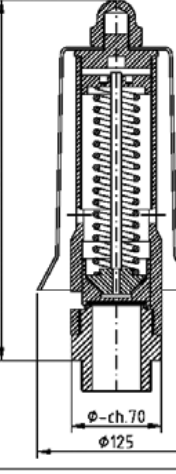
 <p>B38</p> <p>kg. 4,10</p>	Tipo / Type: B38		do: 38 mm		
	Omologazione Homologation		PN	Coefficiente efflusso ridotto Low flow coefficient	Campo di taratura Setting range
	E.D. 2014/68/UE IV^ Cat.(PED)		40	0,76	0,3 - 30,0 bar
	EAC		40	0,76	0,3 - 30,0 bar
	ATEX Ex II 2 G c (1)		40	0,76	0,3 - 30,0 bar
	ATEX Ex II 2 D c		/	/	/
	ASME VIII Div.1		40	0,712	1,0 - 30,0 bar
Canadian Reg. CRN		40	0,712	1,0 - 30,0 bar	
 <p>B38/S</p> <p>kg. 4,00</p>	CONFIGURAZIONE - CONFIGURATION				
	Materiale / Material	Ottone / Brass	Mista Ottone - Acciaio inox Mixed Brass - Stainless steel	Acciaio inox Stainless steel	
	Modelli / Model	Con ghiera With ring nut	Con ghiera With ring nut	Con ghiera With ring nut	
		Senza ghiera Without ring nut	Senza ghiera Without ring nut	Senza ghiera Without ring nut	
		Con protezione With protection	Con protezione With protection	Con protezione With protection	
/ /		/ /	/ /		
/ /	/ /	/ /			
 <p>B38/P</p> <p>kg. 4,80</p>	Sedi di Tenuta Seal System	N.B.R. (Std) -10 / + 100 °C E.P.D.M. - 50 / + 150 °C VITON - 20 / +200 °C SILICONE - 60 / +200 °C PTFE - 196 / +250 °C KALREZ - 20 / +250 °C /	N.B.R. (Std) -10 / + 100 °C E.P.D.M. - 50 / + 150 °C VITON - 20 / +200 °C SILICONE - 60 / +200 °C PTFE - 196 / +250 °C KALREZ - 20 / +250 °C Metal -196 / +250 °C	N.B.R. (Std) - 10 / + 100 °C E.P.D.M. - 50 / + 150 °C VITON - 20 / +200 °C SILICONE - 60 / +200 °C PTFE - 196 / +250 °C KALREZ - 20 / +275 °C Metal - 196 / +450 °C	
	Connessione Entrata Inlet Connection	G.1"1/2 - 2" ISO228 R.1"1/2 - 2" EN10226 1"1/2 - 2" NPT DN50 PN16 - 40 2" 150 - 300 lb / /	G.1"1/2 - 2" ISO228 R.1"1/2 - 2" EN10226 1"1/2 - 2" NPT 2" Tri Clamp DN40 - 50 DIN405 - 11851 DN50 PN16 - 40 2" 150 - 300 lb	G.1"1/2 - 2" ISO228 R.1"1/2 - 2" EN10226 1"1/2 - 2" NPT 2" Tri Clamp DN40 - 50 DIN405 -11851 DN50 PN16-40 2" 150 - 300 lb	
	Connessione Uscita Outlet Connection	/ / / / / /	/ / / / / /	/ / / / / /	
	Connessione Uscita Outlet Connection	/ / / / / /	/ / / / / /	/ / / / / /	

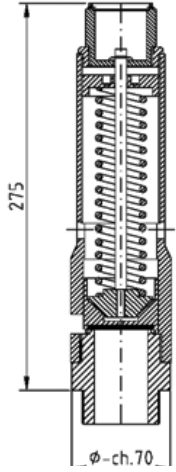
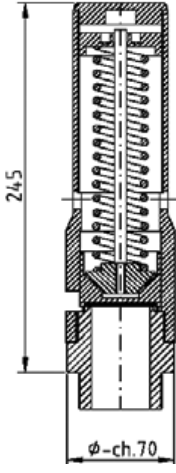
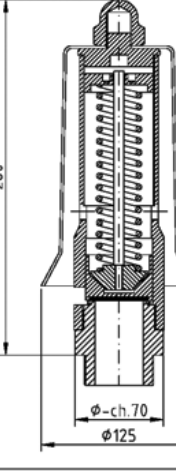
 <p>F40 kg. 3,97</p>	Tipo / Type: F40		do: 40 mm		
	Omologazione Homologation		PN	Coefficiente efflusso ridotto Low flow coefficient	Campo di taratura Setting range
	E.D. 2014/68/UE IV^ Cat.(PED)		40	0,59; >3 bar 0,69	0,3 - 30,0 bar
	EAC		40	0,59; >3 bar 0,69	0,3 - 30,0 bar
	ATEX Ex II 2 G c (1)		40	0,59; >3 bar 0,69	0,3 - 30,0 bar
	ATEX Ex II 2 D c		/	/	/
	ASME VIII Div.1		40	0,712	1,0 - 30,0 bar
	Canadian Reg. CRN		40	0,712	1,0 - 30,0 bar
 <p>F40/S kg. 3,65</p>	CONFIGURAZIONE - CONFIGURATION				
	Materiale / Material		Ottone / Brass	Mista Ottone - Acciaio inox Mixed Brass - Stainless steel	Acciaio inox Stainless steel
	Modelli / Model	Con ghiera With ring nut		Con ghiera With ring nut	Con ghiera With ring nut
		Senza ghiera Without ring nut		Senza ghiera Without ring nut	Senza ghiera Without ring nut
		Con protezione With protection		Con protezione With protection	Con protezione With protection
		/ /		/ /	/ /
/ /		/ /	/ /		
 <p>F40/P kg. 4,40</p>	Sedi di Tenuta Seal System		N.B.R. (Std) - 10 / + 100 °C E.P.D.M. - 50 / + 150 °C VITON - 20 / +200 °C SILICONE - 60 / +200 °C PTFE - 196 / +250 °C KALREZ - 20 / +250 °C /	N.B.R. (Std) - 10 / + 100 °C E.P.D.M. - 50 / + 150 °C VITON - 20 / +200 °C SILICONE - 60 / +200 °C PTFE - 196 / +250 °C KALREZ - 20 / +250 °C METAL - 196 / +250 °C	N.B.R. (Std) - 10 / + 100 °C E.P.D.M. - 50 / + 150 °C VITON - 20 / +200 °C SILICONE - 60 / +200 °C PTFE - 196 / +250 °C KALREZ - 20 / +275 °C METAL - 196 / +450 °C
	Connessione Entrata Inlet Connection		G.1"1/2 - 2" ISO228 R.1"1/2 EN10226 1"1/2 - 2" NPT DN40 - 50 PN16 - 40 1"-2"1/2 150 - 300 lb / /	G.1"1/2 - 2" ISO228 R.1"1/2 - 2" EN10226 1"1/2 - 2" NPT 2" Tri Clamp DN40-50 DIN405-11851 DN40-50 PN16-40 2" - 2"1/2 150-300 lb	G.1"1/2 - 2" ISO228 R.1"1/2 - 2" EN10226 1"1/2 - 2" NPT 2" Tri Clamp DN40 - 50 DIN405 - 11851 DN40 - 50 PN16 - 40 2" - 2"1/2 150 - 300 lb
	Connessione Uscita Outlet Connection		/ / / / / /	/ / / / / /	/ / / / / /
			/ / / / / /	/ / / / / /	/ / / / / /

Note: (1) No Modello Con protezione / No Model With Protection

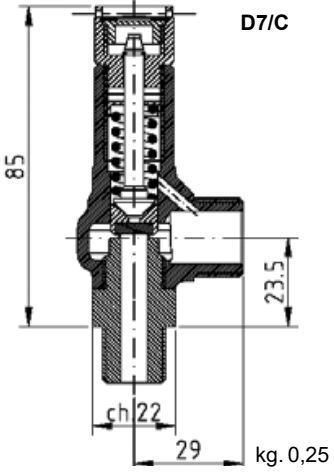
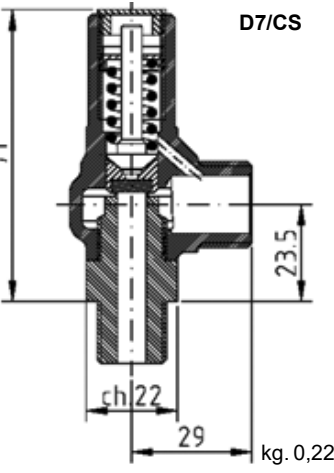
 <p>D7/C kg. 0,25</p>	Tipo / Type: D7/C		do: 7 mm		
	Omologazione Homologation		PN	Coefficiente efflusso ridotto Low flow coefficient	Campo di taratura Setting range
	E.D. 2014/68/UE IV^ Cat.(PED)		60	0,85	0,3 - 60,0 bar
	EAC		60	0,85	0,3 - 60,0 bar
	ATEX Ex II 2 G c		60	0,85	0,3 - 60,0 bar
	ATEX Ex II 2 D c (1)		60	0,85	0,3 - 60,0 bar
	ASME VIII Div.1		40	0,629	1,0 - 40,0 bar
	Canadian Reg. CRN		40	0,629	1,0 - 40,0 bar
 <p>D7/CS kg. 0,22</p>	CONFIGURAZIONE - CONFIGURATION				
	Materiale / Material		Ottone / Brass	Mista Ottone - Acciaio inox Mixed Brass - Stainless steel	Acciaio inox Stainless steel
	Modelli / Model		Con ghiera With ring nut	Con ghiera With ring nut	Con ghiera With ring nut
			Senza ghiera Without ring nut	Senza ghiera Without ring nut	Senza ghiera Without ring nut
			/	/	/
			/	/	/
/			/	/	
Sedi di Tenuta Seal System		N.B.R. (Std) - 10 / + 100 °C E.P.D.M. - 50 / + 150 °C VITON - 20 / +200 °C SILICONE - 60 / +200 °C PTFE - 196 / +250 °C KALREZ - 20 / +250 °C	N.B.R. (Std) - 10 / + 100 °C E.P.D.M. - 50 / + 150 °C VITON - 20 / +200 °C SILICONE - 60 / +200 °C PTFE - 196 / +250 °C KALREZ - 20 / +250 °C	N.B.R. (Std) - 10 / + 100 °C E.P.D.M. - 50 / + 150 °C VITON - 20 / +200 °C SILICONE - 60 / +200 °C PTFE - 196 / +250 °C KALREZ - 20 / +275 °C	
Connessione Entrata Inlet Connection		G.1/4" - 3/8" ISO228 G.3/8" ISO228 F R.1/4" - 3/8" EN10226 1/4" - 3/8" NPT / / / /	G.1/4" - 3/8" ISO228 G.3/8" ISO228 F R.1/4" - 3/8" EN10226 1/4" - 3/8" NPT 3/4" Tri Clamp / / /	G.1/4" - 3/8" ISO228 G.3/8" ISO228 F R.1/4" - 3/8" EN10226 1/4" - 3/8" NPT 3/4" Tri Clamp / / /	
Connessione Uscita Outlet Connection		G.1/2" ISO228 / / / / /	G.1/2" ISO228 / / / / /	G.1/2" ISO228 / / / / /	

Note: (1) No Modello Con leva / No Model With lever

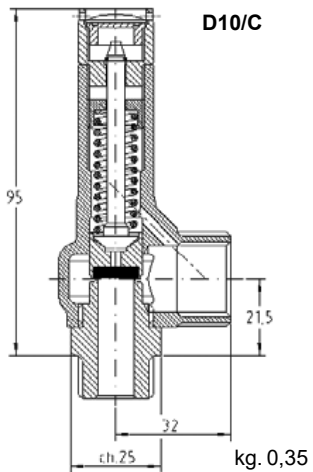
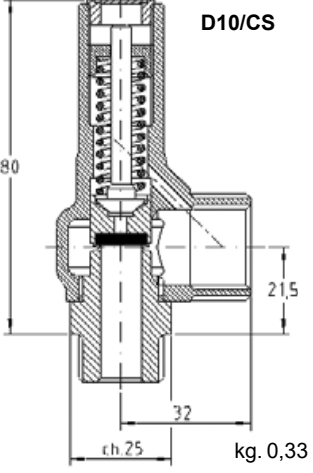
 <p>D10/C</p> <p>kg. 0,35</p>	Tipo / Type: D10C		do: 10 mm		
	Omologazione Homologation		PN	Coefficiente efflusso ridotto Low flow coefficient	Campo di taratura Setting range
	E.D. 2014/68/UE IV^A Cat.(PED)		60	0,77; >3 bar 0,86	0,3 - 60,0 bar
	EAC		60	0,77; >3 bar 0,86	0,3 - 60,0 bar
	ATEX Ex II 2 G c		60	0,77; >3 bar 0,86	0,3 - 60,0 bar
	ATEX Ex II 2 D c (1)		60	0,77; >3 bar 0,86	0,3 - 60,0 bar
	ASME VIII Div.1		40	0,629	1,0 - 40,0 bar
	Canadian Reg. CRN		40	0,629	1,0 - 40,0 bar
 <p>D10/CS</p> <p>kg. 0,33</p>	CONFIGURAZIONE - CONFIGURATION				
	Materiale / Material	Ottone / Brass	Mista Ottone - Acciaio inox Mixed Brass - Stainless steel	Acciaio inox Stainless steel	
	Modelli / Model	Con ghiera With ring nut	Con ghiera With ring nut	Con ghiera With ring nut	
		Senza ghiera Without ring nut	Senza ghiera Without ring nut	Senza ghiera Without ring nut	
		/	/	/	
		/	/	/	
Sedi di Tenuta Seal System	N.B.R. (Std) -10 / + 100 °C	N.B.R. (Std) -10 / + 100 °C	N.B.R. (Std) -10 / + 100 °C		
	E.P.D.M. - 50 / + 150 °C	E.P.D.M. - 50 / + 150 °C	E.P.D.M. - 50 / + 150 °C		
	VITON - 20 / +200 °C	VITON - 20 / +200 °C	VITON - 20 / +200 °C		
	SILICONE - 60 / +200 °C	SILICONE - 60 / +200 °C	SILICONE - 60 / +200 °C		
Connessione Entrata Inlet Connection	G.3/8" - 1/2" ISO228	G.3/8" - 1/2" ISO228	G.3/8" - 1/2" ISO228		
	G.1/2" ISO228 F	G.1/2" ISO228 F	G.1/2" ISO228 F		
	R.3/8" - 1/2" EN10226	R.3/8" - 1/2" EN10226	R.3/8" - 1/2" EN10226		
	3/8" - 1/2" NPT DN15	3/8" - 1/2" NPT	3/8" - 1/2" NPT		
Connessione Uscita Outlet Connection	PN16 - 40	3/4" Tri Clamp DN15	3/4" Tri Clamp DN15		
	1/2" 150 - 300 lb	PN16 - 40 - 60 1/2" 150 - 300 lb	PN16 - 40 - 60 1/2" 150 - 300 lb		
	/	/	/		
	/	/	/		
Connessione Uscita Outlet Connection	G.3/4" ISO228 DN20	G.3/4" ISO228	G.3/4" ISO228		
	PN16 - 40 - 60	1" - 1 1/2 Tri Clamp	1" - 1 1/2 Tri Clamp		
	/	DN20 PN16 - 40 - 60	DN20 PN16 - 40 - 60		
	/	/	/		

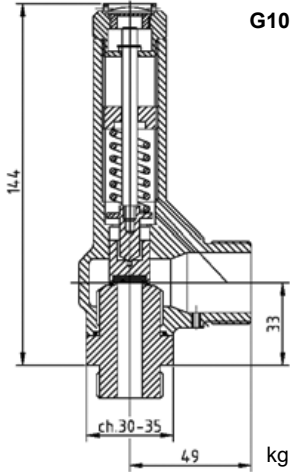
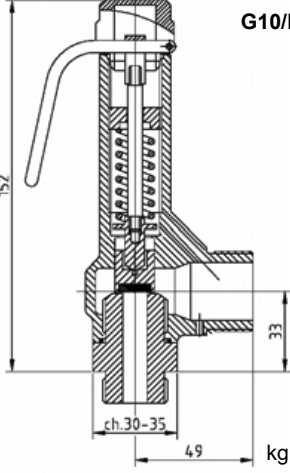
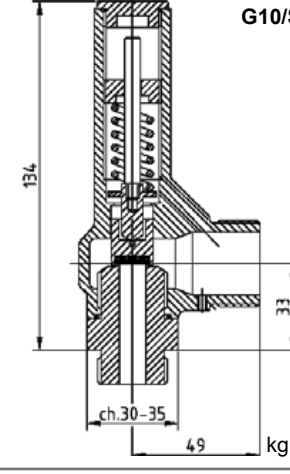
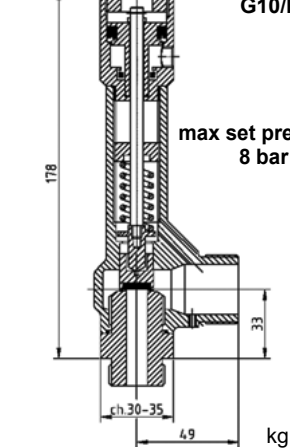
 <p>G10</p> <p>kg. 0,81</p>	Tipo / Type: G10	do: 10 mm		
	Omologazione Homologation	PN	Coefficiente efflusso ridotto Low flow coefficient	Campo di taratura Setting range
	E.D. 2014/68/UE IV^ Cat.(PED)	40	0,85	0,3 - 30,0 bar
	EAC	40	0,85	0,3 - 30,0 bar
	ATEX Ex II 2 G c	40	0,85	0,3 - 30,0 bar
	ATEX Ex II 2 D c (1)	40	0,85	0,3 - 30,0 bar
	ASME VIII Div.1	40	0,629	1,0 - 40,0 bar
	Canadian Reg. CRN	40	0,629	1,0 - 40,0 bar
 <p>G10/L</p> <p>kg. 0,76</p>	CONFIGURAZIONE - CONFIGURATION			
	Materiale / Material	Ottone / Brass	Mista Ottone - Acciaio inox Mixed Brass - Stailnes steel	Acciaio inox Stailnes steel
	Modelli / Model	Con ghiera With ring nut	Con ghiera With ring nut	Con ghiera With ring nut
		Senza ghiera Without ring nut	Senza ghiera Without ring nut	Senza ghiera Without ring nut
		Con leva With lever	Con leva With lever	Con leva With lever
		/ /	/ /	Con apertura pneumatica With pneumatic opening
/ /		/ /	Pneumatica con sensore Pneumatic with sensor	
 <p>G10/S</p> <p>kg. 0,68</p>	Sedi di Tenuta Seal System	N.B.R. (Std) - 10 / + 100 °C E.P.D.M. - 50 / + 150 °C VITON - 20 / +200 °C SILICONE - 60 / +200 °C PTFE - 196 / +250 °C KALREZ - 20 / +250 °C /	N.B.R. (Std) - 10 / + 100 °C E.P.D.M. - 50 / + 150 °C VITON - 20 / +200 °C SILICONE - 60 / +200 °C PTFE - 196 / +250 °C KALREZ - 20 / +250 °C METAL - 196 / +250 °C	N.B.R. (Std) - 10 / + 100 °C E.P.D.M. - 50 / + 150 °C VITON - 20 / +200 °C SILICONE - 60 / +200 °C PTFE - 196 / +250 °C KALREZ - 20 / +275°C METAL - 196 / +450 °C
	Connessione Entrata Inlet Connection	G.3/8"-1/2"-3/4"-1"ISO228 R3/8"-1/2"-3/4"-1"EN10226 3/8" - 1/2" - 3/4" - 1" NPT DN15-20-25 PN16-40 1/2" - 3/4" - 1" 150-300 lb / /	G.3/8"-1/2"-3/4"-1"ISO228 R3/8"-1/2"-3/4"-1"EN10226 3/8" - 1/2" - 3/4" - 1" NPT 1" - 1 1/2 Tri Clamp DN25 DIN405-11851 DN15-20-25 PN16-40 1/2" - 3/4" - 1" 150-300 lb	G.3/8"-1/2"-3/4"-1"ISO228 R3/8"-1/2"-3/4"-1"EN10226 3/8" - 1/2" - 3/4" - 1" NPT 1" - 1 1/2 Tri Clamp DN25 DIN405-11851 DN15-20-25 PN16-40 1/2" - 3/4" - 1" 150-300 lb
	Connessione Uscita Outlet Connection	G.1" ISO228 DN25 PN16-40 1" 150-300 lb / / /	G.1" ISO228 1" - 1 1/2 Tri Clamp DN25 DIN405-11851 DN25 PN16-40 1" 150-300 lb / /	G.1" ISO228 1" - 1 1/2 Tri Clamp DN25 DIN405-11851 DN25 PN16-40 1" 150-300 lb / /
 <p>G10/P</p> <p>max set pressure 8 bar</p> <p>kg. 0,88</p>				

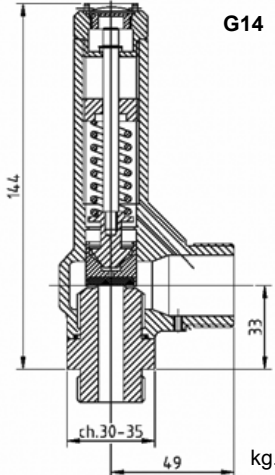
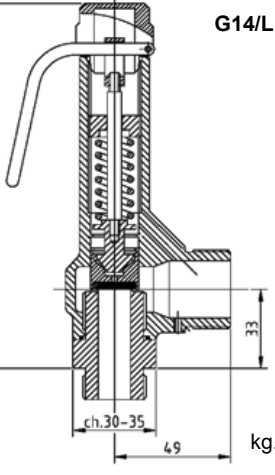
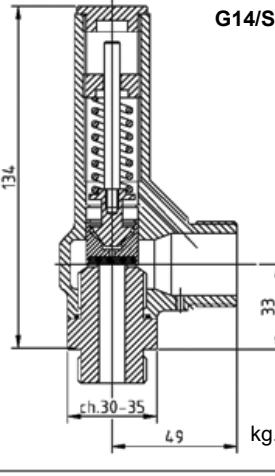
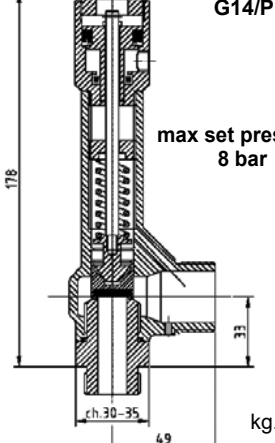
 <p>G14</p> <p>kg. 0,77</p>	<p>Tipo: / Type:</p>	<p>G14</p>	<p>do: 13,5 mm</p>	
<p>Omologazione Homologation</p>	<p>PN</p>	<p>Coefficiente efflusso ridotto Low flow coefficient</p>	<p>Campo di taratura Setting range</p>	
<p>E.D. 2014/68/UE IV^A Cat.(PED)</p>	<p>60</p>	<p>0,81; >3 bar 0,86</p>	<p>0,3 - 60,0 bar</p>	
<p>EAC</p>	<p>60</p>	<p>0,81; >3 bar 0,86</p>	<p>0,3 - 60,0 bar</p>	
<p>ATEX Ex II 2 G c</p>	<p>60</p>	<p>0,81; >3 bar 0,86</p>	<p>0,3 - 60,0 bar</p>	
<p>ATEX Ex II 2 D c (1)</p>	<p>60</p>	<p>0,81; >3 bar 0,86</p>	<p>0,3 - 60,0 bar</p>	
<p>ASME VIII Div.1</p>	<p>60</p>	<p>0,629</p>	<p>1,0 - 60,0 bar</p>	
<p>Canadian Reg. CRN</p>	<p>60</p>	<p>0,629</p>	<p>1,0 - 60,0 bar</p>	
 <p>G14/L</p> <p>kg. 0,78</p>	<p>CONFIGURAZIONE - CONFIGURATION</p>			
<p>Materiale / Material</p>	<p>Ottone / Brass</p>	<p>Mista Ottone - Acciaio inox Mixed Brass - Stainless steel</p>	<p>Acciaio inox Stainless steel</p>	
<p>Modelli / Model</p>	<p>Con ghiera With ring nut</p>	<p>Con ghiera With ring nut</p>	<p>Con ghiera With ring nut</p>	
	<p>Senza ghiera Without ring nut</p>	<p>Senza ghiera Without ring nut</p>	<p>Senza ghiera Without ring nut</p>	
	<p>Con leva With lever</p>	<p>Con leva With lever</p>	<p>Con leva With lever</p>	
	<p>/</p>	<p>/</p>	<p>Con apertura pneumatica With pneumatic opening</p>	
	<p>/</p>	<p>/</p>	<p>Pneumatica con sensore Pneumatic with sensor</p>	
 <p>G14/S</p> <p>kg. 0,74</p>	<p>Sedi di Tenuta Seal System</p>			
	<p>N.B.R. (Std) -10 / + 100 °C E.P.D.M. - 50 / + 150 °C VITON - 20 / +200 °C SILICONE - 60 / +200 °C PTFE - 196 / +250 °C KALREZ - 20 / +250 °C /</p>	<p>N.B.R. (Std) -10 / + 100 °C E.P.D.M. - 50 / + 150 °C VITON - 20 / +200 °C SILICONE - 60 / +200 °C PTFE - 196 / +250 °C KALREZ - 20 / +250 °C Metal -196 / +250 °C</p>	<p>N.B.R. (Std) -10 / + 100 °C E.P.D.M. - 50 / + 150 °C VITON - 20 / +200 °C SILICONE - 60 / +200 °C PTFE -196 / +250 °C KALREZ - 20 / +275 °C Metal -196 / +450 °C</p>	
 <p>G14/P</p> <p>max set pressure 8 bar</p> <p>kg. 0,94</p>	<p>Connessione Entrata Inlet Connection</p>			
	<p>G.1/2" - 3/4" - 1" ISO228 G.3/4" ISO228 F R.1/2" - 3/4" - 1" EN10226 1/2" - 3/4" - 1" NPT DN20 - 25 PN16 - 40 - 60 3/4" - 1" 150 - 300 lb / /</p>	<p>G.1/2" - 3/4" - 1" ISO228 G.3/4" ISO228 F R.1/2" - 3/4" - 1" EN10226 1/2" - 3/4" - 1" NPT 1" - 1"1/2 Tri Clamp DN25 DIN405 - 11851 DN20 - 25 PN16 - 40 - 60 3/4" - 1" 150 - 300 lb</p>	<p>G.1/2" - 3/4" - 1" ISO228 G.3/4" ISO228 F R.1/2" - 3/4" - 1" EN10226 1/2" - 3/4" - 1" NPT 1" - 1"1/2 Tri Clamp DN25 DIN405 - 11851 DN20 - 25 PN16 - 40 - 60 3/4" - 1" 150 - 300 lb</p>	
	<p>Connessione Uscita Outlet Connection</p>			
	<p>G.1" ISO228 DN25 PN16 - 40 - 60 1" 150 - 300 lb / / /</p>	<p>G.1" ISO228 1"1/2 Tri Clamp DN25 DIN405 - 11851 DN25 PN16 - 40 - 60 1" 150 - 300 lb / /</p>	<p>G.1" ISO228 1"1/2 Tri Clamp DN25 DIN405 - 11851 DN25 PN16 - 40 - 60 1" 150 - 300 lb / /</p>	

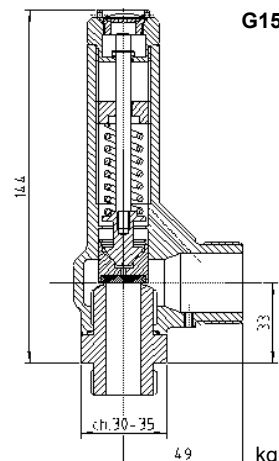
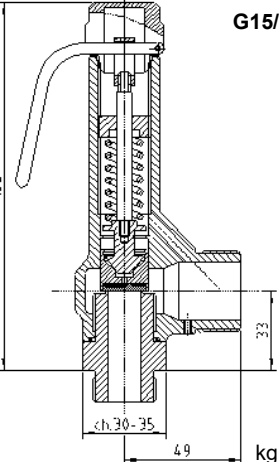
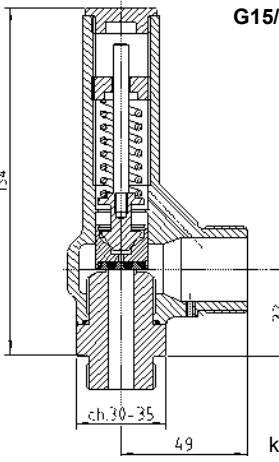
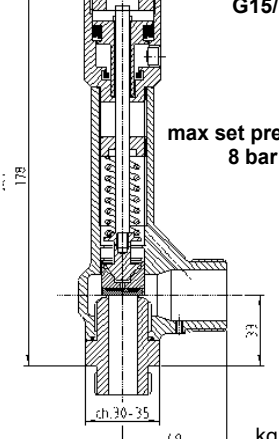
 <p>G15</p> <p>kg. 0,76</p>	<p>Tipo / Type:</p>	<p>G15</p>	<p>do: 15 mm</p>	
<p>Omologazione Homologation</p>	<p>PN</p>	<p>Coefficiente efflusso ridotto Low flow coefficient</p>	<p>Campo di taratura Setting range</p>	
<p>E.D. 2014/68/UE IV[^] Cat.(PED)</p>	<p>25</p>	<p>0,69</p>	<p>0,3 - 16,0 bar</p>	
<p>EAC</p>	<p>25</p>	<p>0,69</p>	<p>0,3 - 16,0 bar</p>	
<p>ATEX Ex II 2 G c</p>	<p>25</p>	<p>0,69</p>	<p>0,3 - 16,0 bar</p>	
<p>ATEX Ex II 2 D c (1)</p>	<p>25</p>	<p>0,69</p>	<p>0,3 - 16,0 bar</p>	
<p>ASME VIII Div.1</p>	<p>/</p>	<p>/</p>	<p>/</p>	
<p>Canadian Reg. CRN</p>	<p>/</p>	<p>/</p>	<p>/</p>	
 <p>G15/L</p> <p>kg. 0,77</p>	<p>CONFIGURAZIONE - CONFIGURATION</p>			
<p>Materiale / Material</p>	<p>Ottone / Brass</p>	<p>Mista Ottone - Acciaio inox Mixed Brass - Stainless steel</p>	<p>Acciaio inox Stainless steel</p>	
<p>Modelli / Model</p>	<p>Con ghiera With ring nut</p>	<p>Con ghiera With ring nut</p>	<p>Con ghiera With ring nut</p>	
	<p>Senza ghiera Without ring nut</p>	<p>Senza ghiera Without ring nut</p>	<p>Senza ghiera Without ring nut</p>	
	<p>Con leva With lever</p>	<p>Con leva With lever</p>	<p>Con leva With lever</p>	
	<p>/</p>	<p>/</p>	<p>Con apertura pneumatica With pneumatic opening</p>	
<p>/</p>	<p>/</p>	<p>/</p>	<p>Pneumatica con sensore Pneumatic with sensor</p>	
 <p>G15/S</p> <p>kg. 0,73</p>	<p>Sedi di Tenuta Seal System</p>	<p>N.B.R. (Std) - 10 / + 100 °C E.P.D.M. - 50 / + 150 °C VITON - 20 / +200 °C SILICONE - 60 / +200 °C PTFE - 196 / +250 °C KALREZ - 20 / +250 °C /</p>	<p>N.B.R. (Std) - 10 / + 100 °C E.P.D.M. - 50 / + 150 °C VITON - 20 / +200 °C SILICONE - 60 / +200 °C PTFE - 196 / +250 °C KALREZ - 20 / +250 °C METAL - 196 / +250 °C</p>	<p>N.B.R. (Std) - 10 / + 100 °C E.P.D.M. - 50 / + 150 °C VITON - 20 / +200 °C SILICONE - 60 / +200 °C PTFE - 196 / +250 °C KALREZ - 20 / +275 °C METAL - 196 / +450 °C</p>
 <p>G15/P</p> <p>max set pressure 8 bar</p> <p>kg. 0,93</p>	<p>Connessione Entrata Inlet Connection</p>	<p>G.1/2" - 3/4" - 1" ISO228 R.1/2" - 3/4" - 1" EN10226 1/2" - 3/4" - 1" NPT DN20-25 PN16-40 3/4" - 1" 150-300 lb / /</p>	<p>G.1/2" - 3/4" - 1" ISO228 R.1/2" - 3/4" - 1" EN10226 1/2" - 3/4" - 1" NPT 1" - 1 1/2 Tri Clamp DN25 DIN405-11851 DN20-25 PN16-40 3/4" - 1" 150-300 lb</p>	<p>G.1/2" - 3/4" - 1" ISO228 R.1/2" - 3/4" - 1" EN10226 1/2" - 3/4" - 1" NPT 1" - 1 1/2 Tri Clamp DN25 DIN405-11851 DN20-25 PN16-40 3/4" - 1" 150-300 lb</p>
<p>Connessione Uscita Outlet Connection</p>	<p>G.1" ISO228 DN25 PN16-40 1" 150-300 lb / / /</p>	<p>G.1" ISO228 1 1/2 Tri Clamp DN25 DIN405-11851 DN25 PN16-40 1" 150-300 lb / / /</p>	<p>G.1" ISO228 1 1/2 Tri Clamp DN25 DIN405-11851 DN25 PN16-40 1" 150-300 lb / /</p>	

Note: (1) No Modello Con leva / No Model With lever

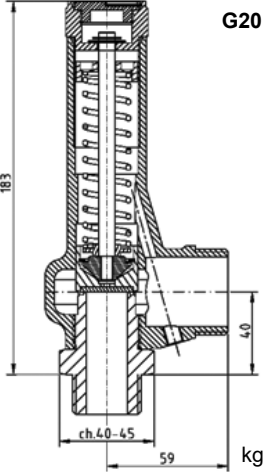
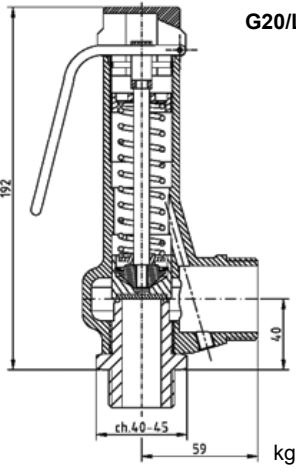
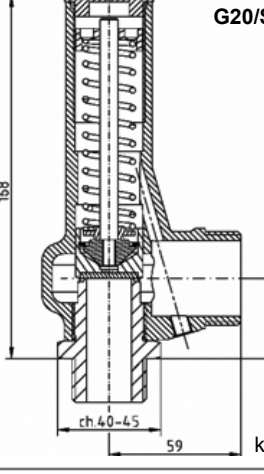
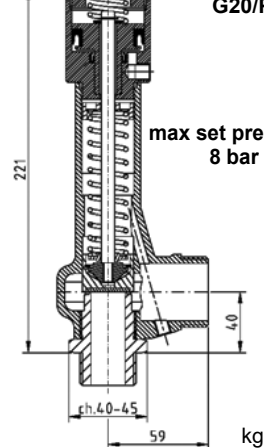
 <p>G20</p> <p>kg. 1,53</p>	Tipo / Type:	G20	do: 20 mm	
	Omologazione Homologation	PN	Coefficiente efflusso ridotto Low flow coefficient	Campo di taratura Setting range
	E.D. 2014/68/UE IV ^A Cat.(PED)	60	0,83	0,3 - 60,0 bar
	EAC	60	0,83	0,3 - 60,0 bar
	ATEX Ex II 2 G c	60	0,83	0,3 - 60,0 bar
	ATEX Ex II 2 D c (1)	60	0,83	0,3 - 60,0 bar
	ASME VIII Div.1	60	0,629	1,0 - 55,0 bar
Canadian Reg. CRN	60	0,629	1,0 - 55,0 bar	
 <p>G20/L</p> <p>kg. 1,64</p>	CONFIGURAZIONE - CONFIGURATION			
	Materiale / Material	Ottone / Brass	Mista Ottone - Acciaio inox Mixed Brass - Stainless steel	Acciaio inox Stainless steel
	Modelli / Model	Con ghiera With ring nut	Con ghiera With ring nut	Con ghiera With ring nut
		Senza ghiera Without ring nut	Senza ghiera Without ring nut	Senza ghiera Without ring nut
		Con leva With lever	Con leva With lever	Con leva With lever
/		/	Con apertura pneumatica With pneumatic opening	
/	/	/	Pneumatica con sensore Pneumatic with sensor	
 <p>G20/S</p> <p>kg. 1,45</p>	Sedi di Tenuta Seal System	N.B.R. (Std) - 10 / + 100 °C	N.B.R. (Std) - 10 / + 100 °C	N.B.R. (Std) - 10 / + 100 °C
		E.P.D.M. - 50 / + 150 °C	E.P.D.M. - 50 / + 150 °C	E.P.D.M. - 50 / + 150 °C
		VITON - 20 / +200 °C	VITON - 20 / +200 °C	VITON - 20 / +200 °C
		SILICONE - 60 / +200 °C	SILICONE - 60 / +200 °C	SILICONE - 60 / +200 °C
		PTFE - 196 / +250 °C	PTFE - 196 / +250 °C	PTFE - 196 / +250 °C
KALREZ - 20 / +250 °C	KALREZ - 20 / +250 °C	KALREZ - 20 / +275 °C	KALREZ - 20 / +275 °C	
/	/	METAL - 196 / +250 °C	METAL - 196 / +450 °C	
 <p>G20/P</p> <p>max set pressure 8 bar</p> <p>kg. 2,35</p>	Connessione Entrata Inlet Connection	G.1" - 1"1/4 ISO228	G.1" - 1"1/4 ISO228	G.1" - 1"1/4 ISO228
		G.1" - 1"1/4 ISO228 F	G.1" - 1"1/4 ISO228 F	G.1" - 1"1/4 ISO228 F
		R.1" - 1"1/4 EN10226	R.1" - 1"1/4 EN10226	R.1" - 1"1/4 EN10226
		1" - 1"1/4 NPT	1" - 1"1/4 NPT	1" - 1"1/4 NPT
DN25 - 32 PN16 - 40 - 60	1" - 1"1/2 Tri Clamp	1" - 1"1/2 Tri Clamp	1" - 1"1/2 Tri Clamp	
1" - 1"1/4 150 - 300 lb /	DN25 - 32 - 40 DIN405 - 11851	DN25 - 32 - 40 DIN405 - 11851	DN25 - 32-40 DIN405 - 11851	
/	DN25 - 32 PN16 - 40 - 60	DN25 - 32 PN16 - 40 - 60	DN25 - 32 PN16 - 40-60	
/	1" - 1"1/4 150 - 300 lb	1" - 1"1/4 150 - 300 lb	1" - 1"1/4 150 - 300 lb	
Connessione Uscita Outlet Connection	G.1"1/4 ISO228	G.1"1/4 ISO228	G.1"1/4 ISO228	
	DN32-40 PN16-40-60	1"1/2 Tri Clamp	1"1/2 Tri Clamp	
	1"1/4 - 1"1/2 150-300 lb	DN25-32-40 DIN405-11851	DN25-32-40 DIN405-11851	
	/	DN32 - 40 PN16-40 - 60	DN32-40 PN16-40-60 1"1/4	
/	1"1/4 - 1"1/2 150 - 300 lb	1"1/2 150-300 lb	/	
/	/	/	/	
/	/	/	/	

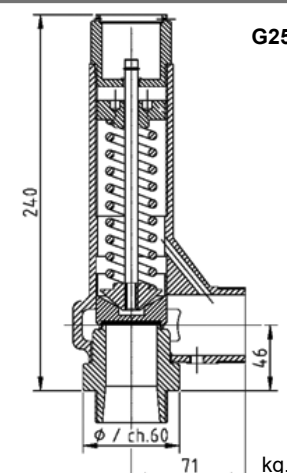
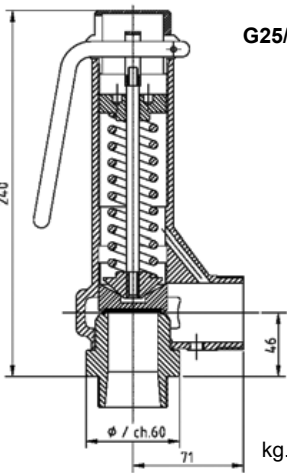
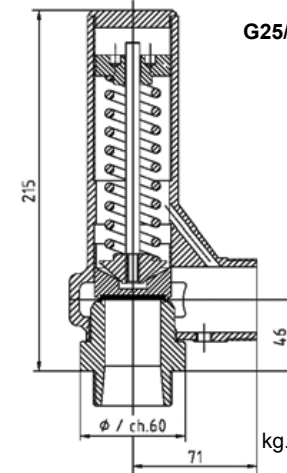
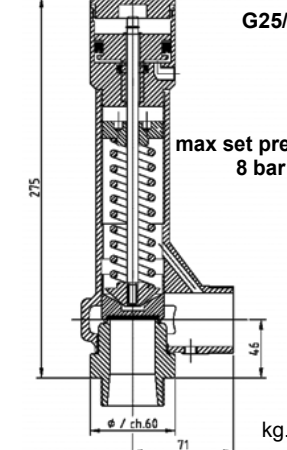
 <p>G25</p> <p>kg. 3,38</p>	<p>Tipo / Type:</p>	<p>G25 do: 25 mm</p>					
	<p>Omologazione Homologation</p>	<p>PN</p>	<p>Coefficiente efflusso ridotto Low flow coefficient</p>	<p>Campo di taratura Setting range</p>			
	<p>E.D. 2014/68/UE IV[^] Cat.(PED)</p>	<p>60</p>	<p>0,78</p>	<p>0,3 - 60,0 bar</p>			
	<p>EAC</p>	<p>60</p>	<p>0,78</p>	<p>0,3 - 60,0 bar</p>			
	<p>ATEX Ex II 2 G c</p>	<p>60</p>	<p>0,78</p>	<p>0,3 - 60,0 bar</p>			
	<p>ATEX Ex II 2 D c (1)</p>	<p>60</p>	<p>0,78</p>	<p>0,3 - 60,0 bar</p>			
	<p>ASME VIII Div.1</p>	<p>40</p>	<p>0,629</p>	<p>1,0 - 30,0 bar</p>			
	<p>Canadian Reg. CRN</p>	<p>40</p>	<p>0,629</p>	<p>1,0 - 30,0 bar</p>			
 <p>G25/L</p> <p>kg. 3,30</p>	<p>CONFIGURAZIONE - CONFIGURATION</p>						
	<p>Materiale / Material</p>	<p>Ottone / Brass</p>	<p>Mista Ottone - Acciaio inox Mixed Brass - Stainless steel</p>	<p>Acciaio inox Stainless steel</p>			
	<p>Modelli / Model</p>	<p>Con ghiera With ring nut</p>	<p>Con ghiera With ring nut</p>	<p>Con ghiera With ring nut</p>			
		<p>Senza ghiera Without ring nut</p>	<p>Senza ghiera Without ring nut</p>	<p>Senza ghiera Without ring nut</p>			
		<p>Con leva With lever</p>	<p>Con leva With lever</p>	<p>Con leva With lever</p>			
		<p>/</p>	<p>/</p>	<p>Con apertura pneumatica With pneumatic opening</p>			
<p>/</p>		<p>/</p>	<p>Pneumatica con sensore Pneumatic with sensor</p>				
<p>Sedi di Tenuta Seal System</p>	<p>N.B.R. (Std) -10 / + 100 °C</p>	<p>N.B.R. (Std) -10 / + 100 °C</p>	<p>N.B.R. (Std) -10 / + 100 °C</p>				
	<p>E.P.D.M. - 50 / + 150 °C</p>	<p>E.P.D.M. - 50 / + 150 °C</p>	<p>E.P.D.M. - 50 / + 150 °C</p>				
	<p>VITON - 20 / +200 °C</p>	<p>VITON - 20 / +200 °C</p>	<p>VITON - 20 / +200 °C</p>				
	<p>SILICONE - 60 / +200 °C</p>	<p>SILICONE - 60 / +200 °C</p>	<p>SILICONE - 60 / +200 °C</p>				
	<p>PTFE - 196 / +250 °C</p>	<p>PTFE - 196 / +250 °C</p>	<p>PTFE -196 / +250 °C</p>				
<p>Connessione Entrata Inlet Connection</p>	<p>G.1"1/4 - 1"1/2 ISO228</p>	<p>G.1"1/4 - 1"1/2 ISO228</p>	<p>G.1"1/4 - 1"1/2 ISO228</p>				
	<p>G.1"1/2 ISO228 F</p>	<p>G.1"1/2 ISO228 F</p>	<p>G.1"1/2 ISO228 F</p>				
	<p>R.1"1/4 - 1"1/2 EN10226</p>	<p>R.1"1/4 - 1"1/2 EN10226</p>	<p>R.1"1/4 - 1"1/2 EN10226</p>				
	<p>1"1/4 - 1"1/2 NPT</p>	<p>1"1/4 - 1"1/2 NPT</p>	<p>1"1/4 - 1"1/2 NPT</p>				
	<p>DN32-40 PN16-40-60</p>	<p>1"1/2 Tri Clamp</p>	<p>1"1/2 Tri Clamp</p>				
<p>Connessione Uscita Outlet Connection</p>	<p>G.1"1/2 ISO228</p>	<p>G.1"1/2 ISO228</p>	<p>G.1"1/2 ISO228</p>				
	<p>DN40-50 PN16-40-60</p>	<p>1"1/2 Tri Clamp</p>	<p>1"1/2 Tri Clamp</p>				
	<p>1"1/2 - 2" 150-300 lb</p>	<p>DN32-40 DIN405-11851</p>	<p>DN32-40 DIN405-11851</p>				
	<p>/</p>	<p>DN40-50 PN16-40-60</p>	<p>DN40-50 PN16-40-60</p>				
	<p>/</p>	<p>1"1/2 - 2" 150-300 lb</p>	<p>1"1/2 - 2" 150-300 lb</p>				
 <p>G25/S</p> <p>kg. 3,10</p>	<p>max set pressure 8 bar</p>	<p>kg. 4,10</p>	<p>kg. 4,10</p>				
				 <p>G25/P</p>	<p>N.B.R. (Std) -10 / + 100 °C</p>	<p>N.B.R. (Std) -10 / + 100 °C</p>	<p>N.B.R. (Std) -10 / + 100 °C</p>
					<p>E.P.D.M. - 50 / + 150 °C</p>	<p>E.P.D.M. - 50 / + 150 °C</p>	<p>E.P.D.M. - 50 / + 150 °C</p>
					<p>VITON - 20 / +200 °C</p>	<p>VITON - 20 / +200 °C</p>	<p>VITON - 20 / +200 °C</p>
					<p>SILICONE - 60 / +200 °C</p>	<p>SILICONE - 60 / +200 °C</p>	<p>SILICONE - 60 / +200 °C</p>
<p>PTFE - 196 / +250 °C</p>	<p>PTFE - 196 / +250 °C</p>	<p>PTFE -196 / +250 °C</p>					
<p>KALREZ - 20 / +250 °C</p>	<p>KALREZ - 20 / +250 °C</p>	<p>KALREZ - 20 / +275 °C</p>					
<p>/</p>	<p>Metal -196 / +250 °C</p>	<p>Metal -196 / +450 °C</p>					
<p>G.1"1/4 - 1"1/2 ISO228</p>	<p>G.1"1/4 - 1"1/2 ISO228</p>	<p>G.1"1/4 - 1"1/2 ISO228</p>					
<p>G.1"1/2 ISO228 F</p>	<p>G.1"1/2 ISO228 F</p>	<p>G.1"1/2 ISO228 F</p>					
<p>R.1"1/4 - 1"1/2 EN10226</p>	<p>R.1"1/4 - 1"1/2 EN10226</p>	<p>R.1"1/4 - 1"1/2 EN10226</p>					
<p>1"1/4 - 1"1/2 NPT</p>	<p>1"1/4 - 1"1/2 NPT</p>	<p>1"1/4 - 1"1/2 NPT</p>					
<p>DN32-40 PN16-40-60</p>	<p>1"1/2 Tri Clamp</p>	<p>1"1/2 Tri Clamp</p>					
<p>1"1/4 - 1"1/2 150-300 lb /</p>	<p>DN25-32-40 DIN405-11851</p>	<p>DN25-32-40 DIN405-11851</p>					
<p>/</p>	<p>DN32-40 PN16-40-60</p>	<p>DN32-40 PN16-40-60</p>					
<p>/</p>	<p>1"1/4 - 2" 150-300 lb</p>	<p>1"1/4 - 2" 150-300 lb</p>					
<p>G.1"1/2 ISO228</p>	<p>G.1"1/2 ISO228</p>	<p>G.1"1/2 ISO228</p>					
<p>DN40-50 PN16-40-60</p>	<p>1"1/2 Tri Clamp</p>	<p>1"1/2 Tri Clamp</p>					
<p>1"1/2 - 2" 150-300 lb</p>	<p>DN32-40 DIN405-11851</p>	<p>DN32-40 DIN405-11851</p>					
<p>/</p>	<p>DN40-50 PN16-40-60</p>	<p>DN40-50 PN16-40-60</p>					
<p>/</p>	<p>1"1/2 - 2" 150-300 lb</p>	<p>1"1/2 - 2" 150-300 lb</p>					
<p>/</p>	<p>/</p>	<p>/</p>					
<p>/</p>	<p>/</p>	<p>/</p>					

Note: (1) No Modello Con leva / No Model With lever

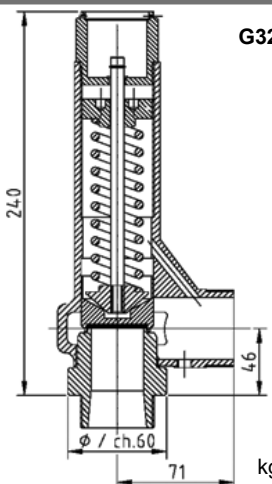
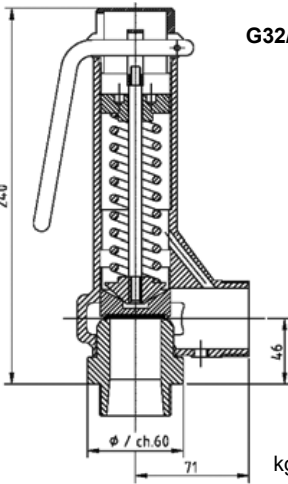
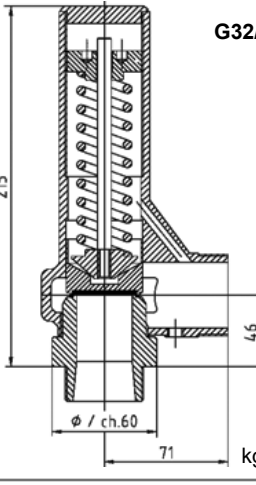
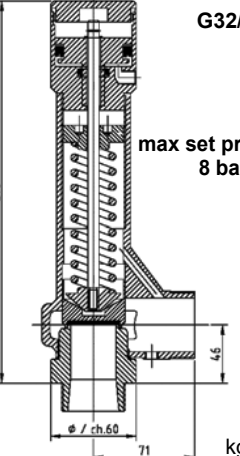
 <p>G32</p> <p>24,0</p> <p>4,6</p> <p>71</p> <p>kg. 3,40</p>	Tipo / Type:	G32	do: 32 mm	
	Omologazione Homologation	PN	Coefficiente efflusso ridotto Low flow coefficient	Campo di taratura Setting range
	E.D. 2014/68/UE IV ^A Cat.(PED)	40	0,53	0,3 - 14,0 bar
	EAC	40	0,53	0,3 - 14,0 bar
	ATEX Ex II 2 G c	40	0,53	0,3 - 14,0 bar
	ATEX Ex II 2 D c (1)	40	0,53	0,3 - 14,0 bar
	ASME VIII Div.1	40	0,629	1,0 - 12,2 bar
Canadian Reg. CRN	40	0,629	1,0 - 12,2 bar	
 <p>G32/L</p> <p>24,0</p> <p>4,6</p> <p>71</p> <p>kg. 3,42</p>	CONFIGURAZIONE - CONFIGURATION			
	Materiale / Material	Ottone / Brass	Mista Ottone - Acciaio inox Mixed Brass - Stainless steel	Acciaio inox Stainless steel
	Modelli / Model	Con ghiera With ring nut	Con ghiera With ring nut	Con ghiera With ring nut
		Senza ghiera Without ring nut	Senza ghiera Without ring nut	Senza ghiera Without ring nut
		Con leva With lever	Con leva With lever	Con leva With lever
/		/	Con apertura pneumatica With pneumatic opening	
/	/	Pneumatica con sensore Pneumatic with sensor		
 <p>G32/S</p> <p>215</p> <p>4,5</p> <p>71</p> <p>kg. 3,20</p>	Sedi di Tenuta Seal System	N.B.R. (Std) - 10 / + 100 °C E.P.D.M. - 50 / + 150 °C VITON - 20 / +200 °C SILICONE - 60 / +200 °C PTFE - 196 / +250 °C KALREZ - 20 / +250 °C /	N.B.R. (Std) - 10 / + 100 °C E.P.D.M. - 50 / + 150 °C VITON - 20 / +200 °C SILICONE - 60 / +200 °C PTFE - 196 / +250 °C KALREZ - 20 / +250 °C METAL - 196 / +250 °C	N.B.R. (Std) - 10 / + 100 °C E.P.D.M. - 50 / + 150 °C VITON - 20 / +200 °C SILICONE - 60 / +200 °C PTFE - 196 / +250 °C KALREZ - 20 / +275°C METAL - 196 / +450 °C
	Connessione Entrata Inlet Connection	G.1"1/2 - 2" ISO228 R.1"1/2 - 2" EN10226 1"1/2 - 2" NPT DN40-50 PN16-40 1"1/2 - 2" 150-300 lb / /	G.1"1/2 - 2" ISO228 R.1"1/2 - 2" EN10226 1"1/2 - 2" NPT 1"1/2 - 2" Tri Clamp DN32-40-50 DIN405-11851 DN40-50 PN16-40 1"1/2 - 2" 150-300 lb	G.1"1/2 - 2" ISO228 R.1"1/2 - 2" EN10226 1"1/2 - 2" NPT 1"1/2 - 2" Tri Clamp DN32-40-50 DIN405-11851 DN40-50 PN16-40 1"1/2 - 2" 150-300 lb
 <p>G32/P</p> <p>max set pressure 8 bar</p> <p>275</p> <p>4,6</p> <p>71</p> <p>kg. 4,20</p>	Connessione Uscita Outlet Connection	G.1"1/2 ISO228 DN40-50 PN16-40 1"1/2 - 2" 150-300 lb / / /	G.1"1/2 ISO228 1"1/2 - 2" Tri Clamp DN40-50 DIN405-11851 DN40-50 PN16-40 1"1/2 - 2" 150-300 lb / /	G.1"1/2 ISO228 1"1/2 - 2" Tri Clamp DN40-50 DIN405-11851 DN40-50 PN16-40 1"1/2 - 2" 150-300 lb / /

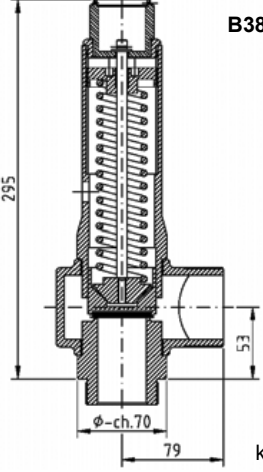
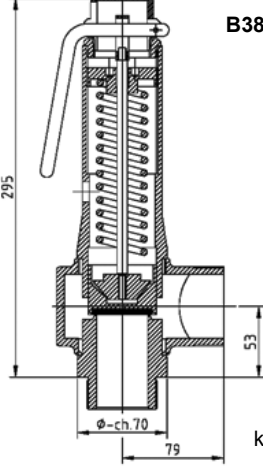
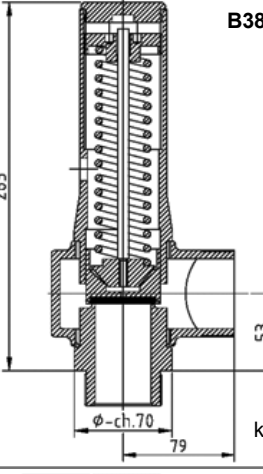
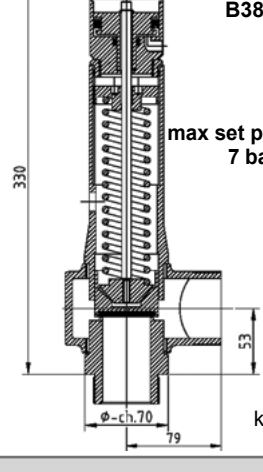
 <p>B38/L</p> <p>kg. 6,00</p>	Tipo / Type:	B38/L		
	do: 38 mm			
	Omologazione <i>Homologation</i>	PN	Coefficiente efflusso ridotto <i>Low flow coefficient</i>	Campo di taratura <i>Setting range</i>
	E.D. 2014/68/UE IV [^] Cat.(PED)	40	0,76	0,3 -30,0 bar
	EAC	40	0,76	0,3 - 30,0 bar
	ATEX Ex II 2 G c	40	0,76	0,3 - 30,0 bar
	ATEX Ex II 2 D c (1)	40	0,76	0,3 - 30,0 bar
	ASME VIII Div.1	40	0,629	1,0 - 30,0 bar
Canadian Reg. CRN	40	0,629	1,0 - 30,0 bar	
 <p>B38/LL</p> <p>kg. 6,77</p>	CONFIGURAZIONE -		CONFIGURATION	
	Materiale / Material	Ottone / Brass	Mista Ottone - Acciaio inox <i>Mixed Brass - Stailnes steel</i>	Acciaio inox <i>Stailnes steel</i>
	Modelli / Model	Con ghiera <i>With ring nut</i>	Con ghiera <i>With ring nut</i>	Con ghiera <i>With ring nut</i>
		Senza ghiera <i>Without ring nut</i>	Senza ghiera <i>Without ring nut</i>	Senza ghiera <i>Without ring nut</i>
		Con leva <i>With lever</i>	Con leva <i>With lever</i>	Con leva <i>With lever</i>
		/	/	Con apertura pneumatica <i>With pneumatic opening</i>
/		/	Pneumatica con sensore <i>Pneumatic with sensor</i>	
Sedi di Tenuta <i>Seal System</i>	N.B.R. (Std) -10 / + 100 °C	N.B.R. (Std) -10 / + 100 °C	N.B.R. (Std) -10 / + 100 °C	
	E.P.D.M. - 50 / + 150 °C	E.P.D.M. - 50 / + 150 °C	E.P.D.M. - 50 / + 150 °C	
	VITON - 20 / +200 °C	VITON - 20 / +200 °C	VITON - 20 / +200 °C	
	SILICONE - 60 / +200 °C	SILICONE - 60 / +200 °C	SILICONE - 60 / +200 °C	
PTFE - 196 / +250 °C	PTFE - 196 / +250 °C	PTFE -196 / +250 °C		
KALREZ - 20 / +250 °C	KALREZ - 20 / +250 °C	KALREZ - 20 / +275 °C		
/	Metal -196 / +250 °C	Metal -196 / +450 °C		
Connessione Entrata <i>Inlet</i> Connection	G.1"1/2 - 2" ISO228	G.1"1/2 - 2" ISO228	G.1"1/2 - 2" ISO228	
	R.1"1/2 - 2" EN10226	R.1"1/2 - 2" EN10226	R.1"1/2 - 2" EN10226	
	1"1/2 - 2" NPT DN50	1"1/2 - 2" NPT	1"1/2 - 2" NPT	
	PN16-40	2" Tri Clamp	2" Tri Clamp	
2" 150-300 lb	DN40-50 DIN405-11851	DN40-50 DIN405-11851		
/	DN50 PN16-40	DN50 PN16-40		
/	2" 150-300 lb	2" 150-300 lb		
Connessione Uscita <i>Outlet</i> Connection	G.2" ISO228	G.2" ISO228	G.2" ISO228	
	DN50-65 PN16-40	2" Tri Clamp DN50	2" Tri Clamp DN50	
	2" - 2"1/2 150-300 lb	DIN405-11851	DIN405-11851	
	/	DN50-65 PN16-40	DN50-65 PN16-40	
	/	2" - 2"1/2 150-300 lb	2" - 2"1/2 150-300 lb	
/	/	/		
/	/	/		
 <p>B38/LS</p> <p>kg. 5,80</p>				
	 <p>B38/LP</p> <p>max set pressure 7 bar</p> <p>kg. 6,80</p>			

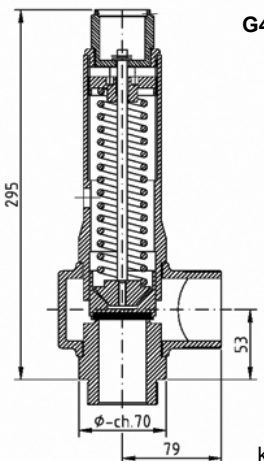
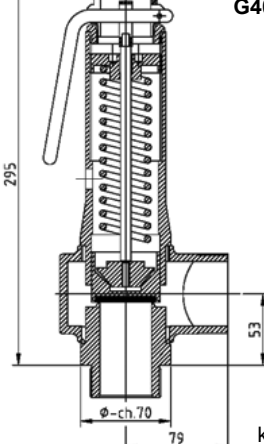
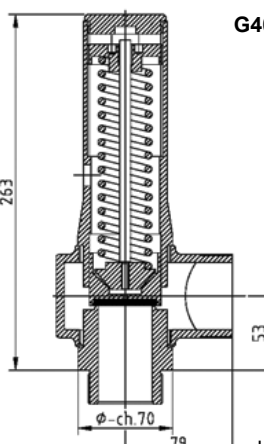
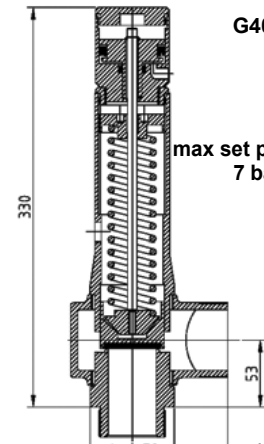
 <p>G40</p> <p>295</p> <p>53</p> <p>79</p> <p>φ-ch.70</p> <p>kg. 5,70</p>	<p>Tipo / Type:</p>	<p>G40</p>	<p>do: 40 mm</p>	
<p>Omologazione Homologation</p>	<p>PN</p>	<p>Coefficiente efflusso ridotto Low flow coefficient</p>	<p>Campo di taratura Setting range</p>	
<p>E.D. 2014/68/UE IV[^] Cat.(PED)</p>	<p>40</p>	<p>0,61; >3 bar 0,71</p>	<p>0,3 - 14,0 bar</p>	
<p>EAC</p>	<p>40</p>	<p>0,61; >3 bar 0,71</p>	<p>0,3 - 14,0 bar</p>	
<p>ATEX Ex II 2 G c</p>	<p>40</p>	<p>0,61; >3 bar 0,71</p>	<p>0,3 - 14,0 bar</p>	
<p>ATEX Ex II 2 D c (1)</p>	<p>40</p>	<p>0,61; >3 bar 0,71</p>	<p>0,3 - 14,0 bar</p>	
<p>ASME VIII Div.1</p>	<p>40</p>	<p>0,629</p>	<p>1,0 - 14,0 bar</p>	
<p>Canadian Reg. CRN</p>	<p>40</p>	<p>0,629</p>	<p>1,0 - 14,0 bar</p>	
 <p>G40/L</p> <p>295</p> <p>53</p> <p>79</p> <p>φ-ch.70</p> <p>kg. 6,47</p>	<p>CONFIGURAZIONE - CONFIGURATION</p>			
<p>Materiale / Material</p>	<p>Ottone / Brass</p>	<p>Mista Ottone - Acciaio inox Mixed Brass - Stainless steel</p>	<p>Acciaio inox Stainless steel</p>	
<p>Modelli / Model</p>	<p>Con ghiera With ring nut</p>	<p>Con ghiera With ring nut</p>	<p>Con ghiera With ring nut</p>	
	<p>Senza ghiera Without ring nut</p>	<p>Senza ghiera Without ring nut</p>	<p>Senza ghiera Without ring nut</p>	
	<p>Con leva With lever</p>	<p>Con leva With lever</p>	<p>Con leva With lever</p>	
	<p>/</p>	<p>/</p>	<p>Con apertura pneumatica With pneumatic opening</p>	
	<p>/</p>	<p>/</p>	<p>Pneumatica con sensore Pneumatic with sensor</p>	
 <p>G40/S</p> <p>263</p> <p>53</p> <p>79</p> <p>φ-ch.70</p> <p>kg. 5,50</p>	<p>Sedi di Tenuta Seal System</p>	<p>N.B.R. (Std) - 10 / + 100 °C E.P.D.M. - 50 / + 150 °C VITON - 20 / +200 °C SILICONE - 60 / +200 °C PTFE - 196 / +250 °C KALREZ - 20 / +250 °C /</p>	<p>N.B.R. (Std) - 10 / + 100 °C E.P.D.M. - 50 / + 150 °C VITON - 20 / +200 °C SILICONE - 60 / +200 °C PTFE - 196 / +250 °C KALREZ - 20 / +250 °C METAL - 196 / +250 °C</p>	<p>N.B.R. (Std) - 10 / + 100 °C E.P.D.M. - 50 / + 150 °C VITON - 20 / +200 °C SILICONE - 60 / +200 °C PTFE - 196 / +250 °C KALREZ - 20 / +275°C METAL - 196 / +450 °C</p>
 <p>G40/P</p> <p>max set pressure 7 bar</p> <p>330</p> <p>53</p> <p>φ-ch.70</p> <p>kg. 6,50</p>	<p>Connessione Entrata Inlet Connection</p>	<p>G.1"1/2 - 2" ISO228 R.1"1/2 - 2" EN10226 1"1/2 - 2" NPT DN50 PN16-40 2" 150-300 lb / /</p>	<p>G.1"1/2 - 2" ISO228 R.1"1/2 - 2" EN10226 1"1/2 - 2" NPT 2" Tri Clamp DN40-50 DIN405-11851 DN50 PN16-40 2" 150-300 lb</p>	<p>G.1"1/2 - 2" ISO228 R.1"1/2 - 2" EN10226 1"1/2 - 2" NPT 2" Tri Clamp DN40-50 DIN405-11851 DN50 PN16-40 2" 150-300 lb</p>
<p>Connessione Uscita Outlet Connection</p>	<p>G.2" ISO228 DN50-65 PN16-40 2" - 2"1/2 150-300 lb / / /</p>	<p>G.2" ISO228 2" Tri Clamp DN50 DIN405-11851 DN50-65 PN16-40 2" - 2"1/2 150-300 lb / /</p>	<p>G.2" ISO228 2" Tri Clamp DN50 DIN405-11851 DN50-65 PN16-40 2" - 2"1/2 150-300 lb / /</p>	

SAFETY

SCARICO CONVOGLIATO / PIPED OUTLET

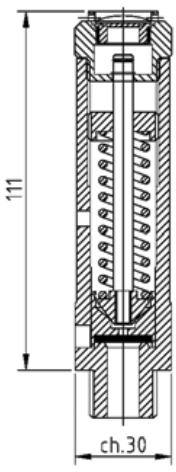
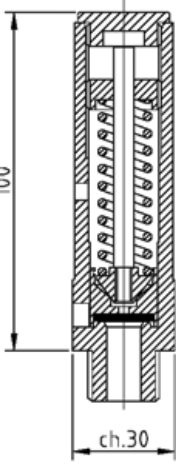

 <p>E10 kg. 0,50</p>	Tipo / Type: E10		do: 10 mm		
	Omologazione Homologation		PN	Coefficiente efflusso ridotto Low flow coefficient	Campo di taratura Setting range
	E.D. 2014/68/UE IV^ Cat.(PED)		100	0,85	0,3 - 100,0 bar
	EAC		100	0,85	0,3 - 100,0 bar
	ATEX Ex II 2 G c (1)		100	0,85	0,3 - 100,0 bar
	ATEX Ex II 2 D c		/	/	/
	ASME VIII Div.1		150	0,712	1,0 - 106,0 bar
	Canadian Reg. CRN		150	0,712	1,0 - 106,0 bar
 <p>E10/S kg. 0,43</p>	CONFIGURAZIONE - CONFIGURATION				
	Materiale / Material		Ottone / Brass	Mista Ottone - Acciaio inox Mixed Brass - Stainless steel	Acciaio inox Stainless steel
	Modelli / Model		Con ghiera With ring nut	/	Con ghiera With ring nut
			Senza ghiera Without ring nut	/	Senza ghiera Without ring nut
			Con protezione With Protection	/	Con protezione With Protection
			/	/	/
/			/	/	
Sedi di Tenuta Seal System		N.B.R. (Std) - 10 / + 100 °C E.P.D.M. - 50 / + 150 °C VITON - 20 / +200 °C SILICONE - 60 / +200 °C PTFE - 196 / +250 °C KALREZ - 20 / +250 °C /	/ / / / / /	N.B.R. (Std) - 10 / + 100 °C E.P.D.M. - 50 / + 150 °C VITON - 20 / +200 °C SILICONE - 60 / +200 °C PTFE - 196 / +250 °C KALREZ - 20 / +275°C /	
Connessione Entrata Inlet Connection		GG.1/2" - 3/4" ISO228 R.1/2" - 3/4" EN10226 1/2" - 3/4" NPT / / / /	/ / / / / /	G.1/2" - 3/4" ISO228 R.1/2" - 3/4" EN10226 1/2" - 3/4" NPT 1" - 1 1/2 Tri Clamp / / /	
Connessione Uscita Outlet Connection		/ / / / / /	/ / / / / /	/ / / / / /	

Note: (1) No Modello Con protezione / No Model With Protection

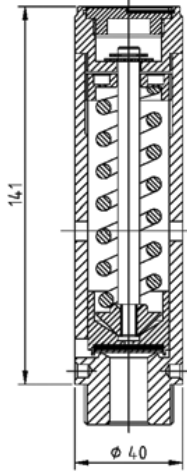
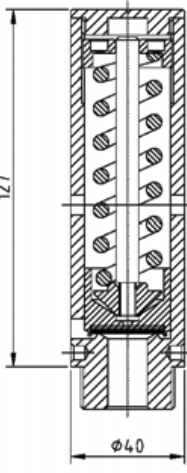
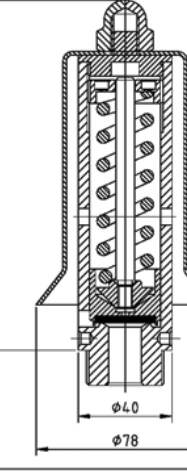
 <p>E14</p> <p>kg.0,97</p>	Tipo / Type:	E14		do: 14 mm		
	Omologazione Homologation	PN	Coefficiente efflusso ridotto Low flow coefficient	Campo di taratura Setting range		
	E.D. 2014/68/UE IV^ Cat.(PED)	100	0,89	0,3 -100,0 bar		
	EAC	100	0,89	0,3 - 100,0 bar		
	ATEX Ex II 2 G c (1)	100	0,89	0,3 - 100,0 bar		
	ATEX Ex II 2 D c	/	/	/		
	ASME VIII Div.1	100	0,712	1,0 - 80,0 bar		
	Canadian Reg. CRN	100	0,712	1,0 - 80,0 bar		
 <p>E14/S</p> <p>kg. 0,95</p>	CONFIGURAZIONE - CONFIGURATION					
	Materiale / Material	Ottone / Brass	Mista Ottone - Acciaio inox Mixed Brass - Stainless steel	Acciaio inox Stainless steel		
	Modelli / Model	Con ghiera With ring nut	Con ghiera With ring nut	Con ghiera With ring nut	Con ghiera With ring nut	
		Senza ghiera Without ring nut	Senza ghiera Without ring nut	Senza ghiera Without ring nut	Senza ghiera Without ring nut	
		Con protezione With Protection	Con protezione With Protection	Con protezione With Protection	Con protezione With Protection	
		/ /	/ /	/ /	/ /	
/ /		/ /	/ /	/ /		
Sedi di Tenuta Seal System	N.B.R. (Std) -10 / + 100 °C E.P.D.M. - 50 / + 150 °C VITON - 20 / +200 °C SILICONE - 60 / +200 °C PTFE - 196 / +250 °C KALREZ - 20 / +250 °C /	N.B.R. (Std) -10 / + 100 °C E.P.D.M. - 50 / + 150 °C VITON - 20 / +200 °C SILICONE - 60 / +200 °C PTFE - 196 / +250 °C KALREZ - 20 / +250 °C Metal -196 / +250 °C	N.B.R. (Std) -10 / + 100 °C E.P.D.M. - 50 / + 150 °C VITON - 20 / +200 °C SILICONE - 60 / +200 °C PTFE -196 / +250 °C KALREZ - 20 / +275 °C Metal -196 / +450 °C			
	G.3/4" - 1" ISO228 R.3/4" - 1" EN10226 3/4" - 1" NPT DN25 PN16-100 1" 150-900 lb /	G.3/4" - 1" ISO228 R.3/4" - 1" EN10226 3/4" - 1" NPT 1" - 1"1/2 Tri Clamp DN25-32 DIN405-11851 DN25 PN16-100 1" 150-900 lb	G.3/4" - 1" ISO228 R.3/4" - 1" EN10226 3/4" - 1" NPT 1" - 1"1/2 Tri Clamp DN25-32 DIN405-11851 DN25 PN16-100 1" 150-900 lb			
	Connessione Entrata Inlet Connection					
	Connessione Uscita Outlet Connection	/ / / / / /	/ / / / / /	/ / / / / /		
 <p>E14/P</p> <p>kg. 1,00</p>						

Note: (1) No Modello Con protezione / No Model With Protection

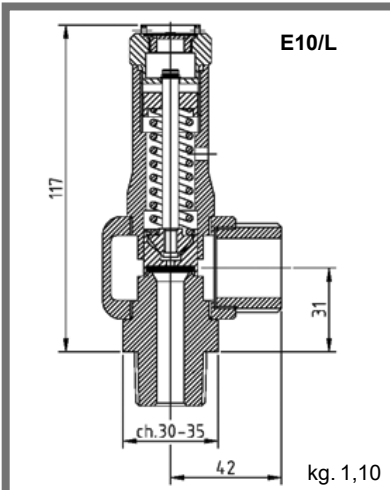

Tipo / Type:	E10L			do: 10 mm
Omologazione Homologation	PN	Coefficiente efflusso ridotto Low flow coefficient	Campo di taratura Setting range	
E.D. 2014/68/UE IV^ Cat.(PED)	100	0,86	0,3 - 100,0 bar	
EAC	100	0,86	0,3 - 100,0 bar	
ATEX Ex II 2 G c	100	0,86	0,3 - 100,0 bar	
ATEX Ex II 2 D c (1)	100	0,86	0,3 - 100,0 bar	
ASME VIII Div.1	150	0,629	1,0 - 106,0 bar	
Canadian Reg. CRN	150	0,629	1,0 - 106,0 bar	

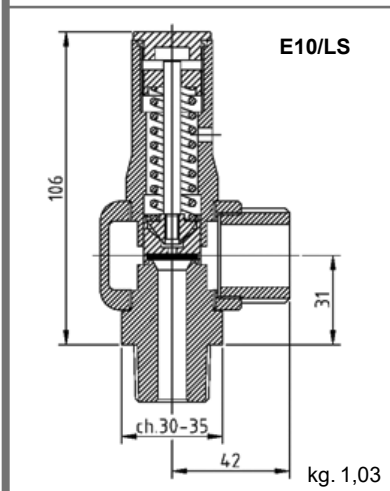

CONFIGURAZIONE -		CONFIGURATION	
Materiale / Material	Ottone / Brass	Mista Ottone - Acciaio inox Mixed Brass - Stailnes steel	Acciaio inox Stailnes steel
Modelli / Model	Con ghiera With ring nut	Con ghiera With ring nut	Con ghiera With ring nut
	Senza ghiera Without ring nut	Senza ghiera Without ring nut	Senza ghiera Without ring nut
	/	/	/
	/	/	/
	/	/	/

Sedi di Tenuta Seal System	N.B.R. (Std) - 10 / + 100 °C E.P.D.M. - 50 / + 150 °C VITON - 20 / +200 °C SILICONE - 60 / +200 °C PTFE - 196 / +250 °C KALREZ - 20 / +250 °C /	N.B.R. (Std) -10 / + 100 °C E.P.D.M. - 50 / + 150 °C VITON - 20 / +200 °C SILICONE - 60 / +200 °C PTFE - 196 / +250 °C KALREZ - 20 / +250 °C Metal - 196 / +250 °C	N.B.R. (Std) - 10 / + 100 °C E.P.D.M. - 50 / + 150 °C VITON - 20 / +200 °C SILICONE - 60 / +200 °C PTFE - 196 / +250 °C KALREZ - 20 / +275 °C Metal - 196 / +450 °C
-------------------------------	---	--	---

Connessione Entrata Inlet Connection	G.1/2" - 3/4" ISO228 R.1/2" - 3/4" EN10226 1/2" - 3/4" NPT DN20-25 PN16-100 3/4" - 1" 150-900 lb / /	G.1/2" - 3/4" ISO228 R.1/2" - 3/4" EN10226 1/2" - 3/4" NPT 1" - 1"1/2 Tri Clamp DN20-25 PN16-100 3/4" - 1" 150-900 lb /	G.1/2" - 3/4" ISO228 R.1/2" - 3/4" EN10226 1/2" - 3/4" NPT 1" - 1"1/2 Tri Clamp DN20-25 PN16-100 3/4" - 1" 150-900 lb /
--	--	---	---

Connessione Uscita Outlet Connection	G.1" ISO228 DN25 PN16-100 1" 150-900 lb / / /	G.1" ISO228 1"1/2 Tri Clamp DN25 DIN405-11851 DN25 PN16-100 1" 150-900 lb / /	G.1" ISO228 1"1/2 Tri Clamp DN25 DIN405-11851 DN25 PN16-100 1" 150-900 lb / /
--	--	---	---

Note: (1) No Modello Con leva / No Model With lever

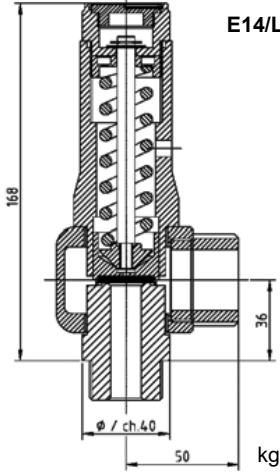
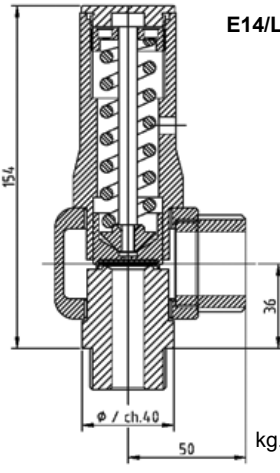
 <p>E14/L</p> <p>kg. 1,00</p>	Tipo / Type: E14		do: 14 mm		
	Omologazione Homologation		PN	Coefficiente efflusso ridotto Low flow coefficient	Campo di taratura Setting range
	E.D. 2014/68/UE IV^ Cat.(PED)		100	0,86	0,3 -100,0 bar
	EAC		100	0,86	0,3 - 100,0 bar
	ATEX Ex II 2 G c		100	0,86	0,3 - 100,0 bar
	ATEX Ex II 2 D c (1)		100	0,86	0,3 - 100,0 bar
	ASME VIII Div.1		100	0,629	1,0 - 80,0 bar
	Canadian Reg. CRN		100	0,629	1,0 - 80,0 bar
 <p>E14/LS</p> <p>kg. 0,98</p>	CONFIGURAZIONE - CONFIGURATION				
	Materiale / Material	Ottone / Brass	Mista Ottone - Acciaio inox Mixed Brass - Stainless steel	Acciaio inox Stainless steel	
	Modelli / Model	Con ghiera With ring nut	Con ghiera With ring nut	Con ghiera With ring nut	
		Senza ghiera Without ring nut	Senza ghiera Without ring nut	Senza ghiera Without ring nut	
		/	/	/	
/		/	/		
Sedi di Tenuta Seal System	N.B.R. (Std) -10 / + 100 °C E.P.D.M. - 50 / + 150 °C VITON - 20 / +200 °C SILICONE - 60 / +200 °C PTFE - 196 / +250 °C KALREZ - 20 / +250 °C /	N.B.R. (Std) -10 / + 100 °C E.P.D.M. - 50 / + 150 °C VITON - 20 / +200 °C SILICONE - 60 / +200 °C PTFE - 196 / +250 °C KALREZ - 20 / +250 °C Metal -196 / +250 °C	N.B.R. (Std) -10 / + 100 °C E.P.D.M. - 50 / + 150 °C VITON - 20 / +200 °C SILICONE - 60 / +200 °C PTFE -196 / +250 °C KALREZ - 20 / +275 °C Metal -196 / +450 °C		
	Connessione Entrata Inlet Connection	G.3/4" - 1" ISO228 R.3/4" - 1" EN10226 3/4" - 1" NPT DN25-32 PN16-100 1" - 1"1/4 150-900 lb / /	G.3/4" - 1" ISO228 R.3/4" - 1" EN10226 3/4" - 1" NPT 1" - 1"1/2 Tri Clamp DN25-32 DIN405-11851 DN25-32 PN16-100 1" - 1"1/4 150-900 l	G.3/4" - 1" ISO228 R.3/4" - 1" EN10226 3/4" - 1" NPT 1" - 1"1/2 Tri Clamp DN25-32 DIN405-11851 DN25-32 PN16-100 1" - 1"1/4 150-900 lb	
		Connessione Uscita Outlet Connection	G.1"1/4 ISO228 DN32-40PN16-100 1"1/4 - 1"1/2 150-900 lb / / /	G.1"1/4 ISO228 1"1/2 Tri Clamp DN32 DIN405-11851 DN32-40 PN16-100 1"1/4 - 1"1/2 150-900 lb / /	G.1"1/4 ISO228 1"1/2 Tri Clamp DN32 DIN405-11851 DN32-40 PN16-100 1"1/4 - 1"1/2 150-900 lb / /

Note: (1) No Modello Con leva / No Model With lever

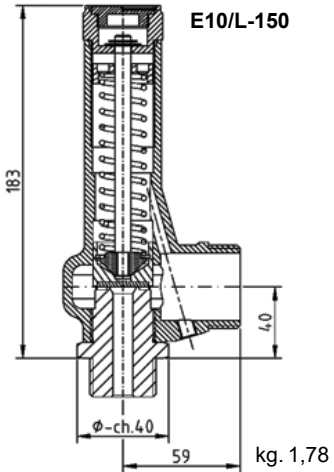
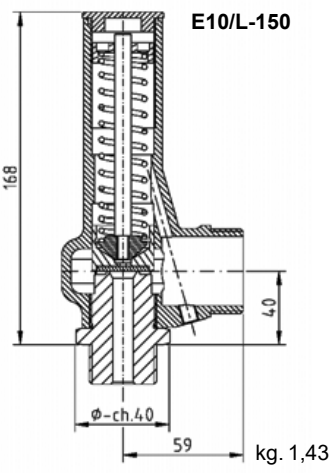
 <p>E10/L-150 kg. 1,78</p>	Tipo / Type: E10L150		do: 10 mm		
	Omologazione Homologation		PN	Coefficiente efflusso ridotto Low flow coefficient	Campo di taratura Setting range
	E.D. 2014/68/UE IV^ Cat.(PED)		150	0,86	100,0 - 150,0 bar
	EAC		150	0,86	100,0 - 150,0 bar
	ATEX Ex II 2 G c		150	0,86	100,0 - 150,0 bar
	ATEX Ex II 2 D c (1)		150	0,86	100,0 - 150,0 bar
	ASME VIII Div.1		/	/	/
	Canadian Reg. CRN		/	/	/
 <p>E10/L-150 kg. 1,43</p>	CONFIGURAZIONE - CONFIGURATION				
	Materiale / Material		Ottone / Brass	Mista Ottone - Acciaio inox Mixed Brass - Stainless steel	Acciaio inox Stainless steel
	Modelli / Model		Con ghiera With ring nut	Con ghiera With ring nut	Con ghiera With ring nut
			Senza ghiera Without ring nut	Senza ghiera Without ring nut	Senza ghiera Without ring nut
			/	/	/
			/	/	/
/			/	/	
Sedi di Tenuta Seal System		N.B.R. (Std) - 10 / + 100 °C E.P.D.M. - 50 / + 150 °C VITON - 20 / +200 °C SILICONE - 60 / +200 °C PTFE - 196 / +250 °C KALREZ - 20 / +250 °C / Peek - 40 / +200 °C	N.B.R. (Std) -10 / + 100 °C E.P.D.M. - 50 / + 150 °C VITON - 20 / +200 °C SILICONE - 60 / +200 °C PTFE - 196 / +250 °C KALREZ - 20 / +250 °C Metal - 196 / +250 °C Peek - 40 / +200 °C	N.B.R. (Std) - 10 / + 100 °C E.P.D.M. - 50 / + 150 °C VITON - 20 / +200 °C SILICONE - 60 / +200 °C PTFE - 196 / +250 °C KALREZ - 20 / +275 °C Metal - 196 / +450 °C Peek - 40 / +200 °C	
Connessione Entrata Inlet Connection		G.3/4" - 1" - 1"1/4 ISO228 R.1/2" - 1" - 1"1/4 EN10226 1/2" - 1" - 1"1/4 NPT DN20-25-32 PN16-160 3/4" - 1" - 1"1/4 150-1500 lb / /	G.3/4" - 1" - 1"1/4 ISO228 R.3/4" - 1" - 1"1/4 EN10226 3/4" - 1" - 1"1/4 NPT 1" - 1"1/2 Tri Clamp DN20-25 PN16-160 3/4" - 1" 150-1500 lb /	G.3/4" - 1" - 1"1/4 ISO228 R.3/4" - 1" - 1"1/4 EN10226 3/4" - 1" - 1"1/4 NPT 1" - 1"1/2 Tri Clamp DN20-25 PN16-160 3/4" - 1" 150-1500 lb /	
Connessione Uscita Outlet Connection		G.1"1/4 ISO228 DN32 PN16-160 1"1/4 150-1500 lb / / /	G.1"1/4 ISO228 1"1/2 Tri Clamp DN32 PN16-160 1"1/4 150-1500 lb / / /	G.1"1/4 ISO228 1"1/2 Tri Clamp DN32 PN16-160 1"1/4 150-1500 lb / / /	

Note: (1) No Modello Con leva / No Model With lever

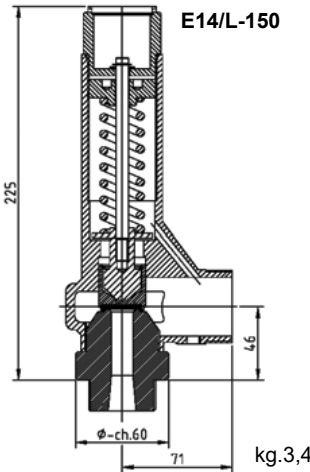
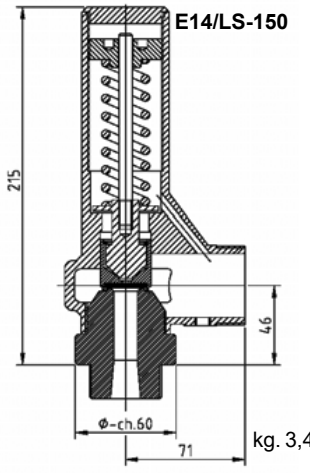
 <p>E14/L-150</p>	Tipo / Type:	E14L150		do: 14 mm	
	Omologazione Homologation	PN	Coefficiente efflusso ridotto Low flow coefficient	Campo di taratura Setting range	
	E.D. 2014/68/UE IV ^A Cat.(PED)	150	0,86	100,0 - 150,0 bar	
	EAC	150	0,86	100,0 - 150,0 bar	
	ATEX Ex II 2 G c	150	0,86	100,0 - 150,0 bar	
	ATEX Ex II 2 D c (1)	150	0,86	100,0 - 150,0 bar	
	ASME VIII Div.1	150	/	/	
	Canadian Reg. CRN	150	/	/	
 <p>E14/LS-150</p>	CONFIGURAZIONE -		CONFIGURATION		
	Materiale / Material	Ottone / Brass	Mista Ottone - Acciaio inox Mixed Brass - Stainless steel	Acciaio inox Stainless steel	
	Modelli / Model	Con ghiera With ring nut	Con ghiera With ring nut	Con ghiera With ring nut	
		Senza ghiera Without ring nut	Senza ghiera Without ring nut	Senza ghiera Without ring nut	
		/	/	/	
		/	/	/	
Sedi di Tenuta Seal System	N.B.R. (Std) -10 / + 100 °C	N.B.R. (Std) -10 / + 100 °C	N.B.R. (Std) -10 / + 100 °C		
	E.P.D.M. - 50 / + 150 °C	E.P.D.M. - 50 / + 150 °C	E.P.D.M. - 50 / + 150 °C		
	VITON - 20 / +200 °C	VITON - 20 / +200 °C	VITON - 20 / +200 °C		
	SILICONE - 60 / +200 °C	SILICONE - 60 / +200 °C	SILICONE - 60 / +200 °C		
Connessione Entrata Inlet Connection	PTFE - 196 / +250 °C	PTFE - 196 / +250 °C	PTFE -196 / +250 °C		
	KALREZ - 20 / +250 °C	KALREZ - 20 / +250 °C	KALREZ - 20 / +275 °C		
	/	Metal -196 / +250 °C Peek -	Metal -196 / +450 °C Peek -		
	Peek - 40 / +200 °C	40 / +200 °C	40 / +200 °C		
Connessione Uscita Outlet Connection	G.1" - 1"1/4 - 1"1/2 ISO228	G.1" - 1"1/4 - 1"1/2 ISO228	G.1" - 1"1/4 - 1"1/2 ISO228		
	R.1" - 1"1/4 - 1"1/2 EN10226	1" - 1"1/4 - 1" 1/2 EN1022	1" - 1"1/4 - 1" 1/2 EN1022		
	1" - 1"1/4 - 1"1/2 NPT DN25-32-40 PN16-160 1"1/4 - 1"1/2 150-1500 l	1" - 1"1/4 - 1" 1/2 NPT 1" - 1"1/2 Tri Clamp DN25-40 DIN405-11851 DN25-32 PN16-160	1" - 1"1/4 - 1" 1/2 NPT 1" - 1"1/2 Tri Clamp DN25-40 DIN405-11851 DN25-32 PN16-160		
	/	1" - 1"1/4 150-1500 lb	1" - 1"1/4 150-1500 lb		
Connessione Uscita Outlet Connection	G.1"1/2 ISO228 DN40 PN16-160 1"1/2 150-1500 lb	G.1"1/2 ISO228 1"1/2 - 2" Tri Clamp DN40 DIN405-11851 DN40 PN16-160 1"1/2 150-1500 lb	G.1"1/2 ISO228 1"1/2 - 2" Tri Clamp DN40 DIN405-11851 DN40 PN16-160 1"1/2 150-1500 lb		
	/	/	/		
	/	/	/		
	/	/	/		

Note: (/) No Modello Con leva / No Model With lever

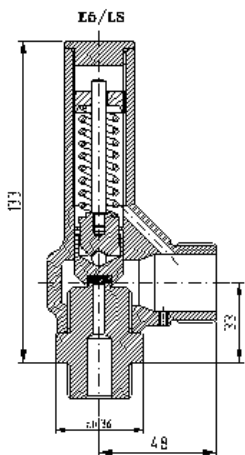

kg. 0,8

Tipo / Type:	E5/LS			do: 5 mm
Omologazione <i>Homologation</i>	PN	Coefficiente efflusso ridotto <i>Low flow coefficient</i>	Campo di taratura <i>Setting range</i>	
E.D. 2014/68/UE IV ^A Cat.(PED)	700	0,828	100,0 - 300,0 bar	
EAC	/	/	/	
ATEX Ex II 2 G c	700	0,828	100,0 - 300,0 bar	
ATEX Ex II 2 D c (1)	700	0,828	100,0 - 300,0 bar	
ASME VIII Div.1	/	/	/	
Canadian Reg. CRN	/	/	/	

CONFIGURAZIONE -		CONFIGURATION	
Materiale / Material	Ottone / Brass	Mista Ottone - Acciaio inox <i>Mixed Brass - Stailnes steel</i>	Acciaio inox <i>Stailnes steel</i>
Modelli / Model	/	/	Senza ghiera <i>Without ring nut</i>
	/	/	/
	/	/	/
	/	/	/
	/	/	/
Sedi di Tenuta <i>Seal System</i>	/	/	PEEK (Std) -40 / + 200 °
	/	/	C /
	/	/	/
	/	/	/
	/	/	/
	/	/	/
Connessione Entrata <i>Inlet</i> Connection	/	/	G.1/2" - 3/4" - 1" ISO228
	/	/	R.1/2" - 3/4" / 1" EN10226
	/	/	1/2" - 3/4" - 1" NPT
	/	/	/
	/	/	/
	/	/	/
Connessione Uscita <i>Outlet</i> Connection	/	/	G.1" ISO228
	/	/	/
	/	/	/
	/	/	/
	/	/	/
	/	/	/

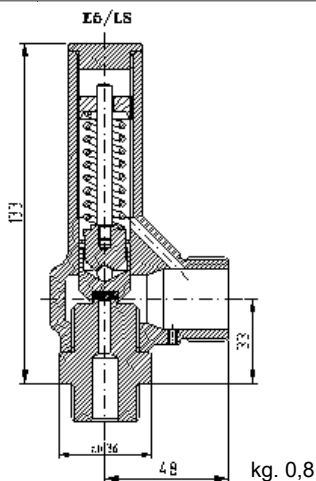

Tipo / Type:	E5/LS600		do: 5 mm	
Omologazione Homologation	PN	Coefficiente efflusso ridotto Low flow coefficient	Campo di taratura Setting range	
E.D. 2014/68/UE IV ^A Cat.(PED)	700	0,828	301,0 - 600,0 bar	
EAC	/	/	/	
ATEX Ex II 2 G c	700	0,828	301,0 - 600,0 bar	
ATEX Ex II 2 D c (1)	700	0,828	301,0 - 600,0 bar	
ASME VIII Div.1	/	/	/	
Canadian Reg. CRN	/	/	/	

CONFIGURAZIONE -		CONFIGURATION	
Materiale / Material	Ottone / Brass	Mista Ottone - Acciaio inox Mixed Brass - Stainless steel	Acciaio inox Stainless steel
Modelli / Model	/	/	Senza ghiera Without ring nut
	/	/	/
	/	/	/
	/	/	/
	/	/	/
Sedi di Tenuta Seal System	/	/	PEEK (Std) -40 / + 200 °
	/	/	C /
	/	/	/
	/	/	/
	/	/	/
	/	/	/
Connessione Entrata Inlet Connection	/	/	G.1/2" - 3/4" - 1" ISO228
	/	/	R.1/2" - 3/4" / 1" EN10226
	/	/	1/2" - 3/4" - 1" NPT
	/	/	/
	/	/	/
	/	/	/
Connessione Uscita Outlet Connection	/	/	G.1" ISO228
	/	/	/
	/	/	/
	/	/	/
	/	/	/
	/	/	/

SAFETY

SCARICO CONVOGLIATO - PVC

PIPED OUTLET - PVC



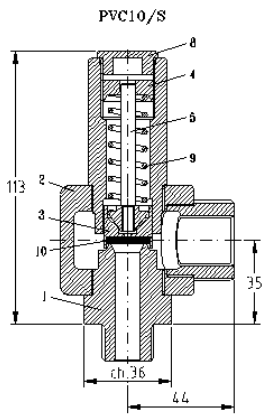

Tipo / Type:

P10/A

do: 10 mm

Omologazione
Homologation

PN

Coefficiente efflusso ridotto
Low flow coefficient

Campo di taratura
Setting range

E.D. 2014/68/UE IV[^] Cat.(PED)

16

0,774

0,2 - 16 bar

EAC

/

/

/

ATEX Ex II 2 G c

/

/

/

ATEX Ex II 2 D c

/

/

/

ASME VIII Div.1

/

/

/

Canadian Reg. CRN

/

/

/

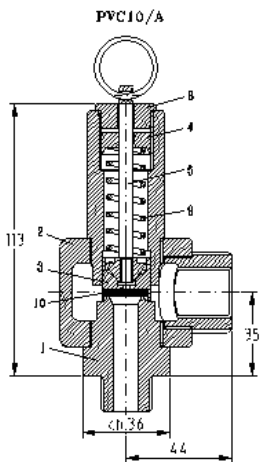

CONFIGURAZIONE -

CONFIGURATION

Materiale / Material

PVC / PVC

Modelli / Model

Senza ghiera
Without ring nut

/

/

Con anellino
With ring

/

/

/

/

/

/

/

/

/

/

/

Sedi di Tenuta
Seal System

N.B.R. (Std) -10 / +85 °C

/

/

E.P.D.M. -15 / +85 °C

/

/

VITON -15 / +85 °C

/

/

SILICONE -15 / +85 °C

/

/

PTFE -15 / +85°C

/

/

KALREZ -15 / +85 °C

/

/

/

/

/

Connessione
Entrata Inlet
Connection

G.1/2" - 3/4"

/

/

ISO228 /

/

/

/

/

/

/

/

/

/

/

/

/

/

/

/

/

/

Connessione
Uscita Outlet
Connection

G.1" ISO228

/

/

/

/

/

/

/

/

/

/

/

/

/

/

/

/

/

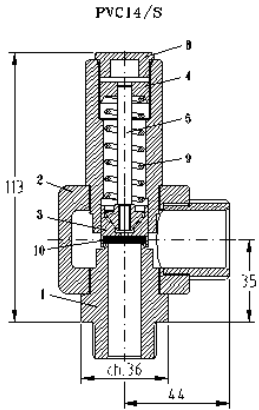
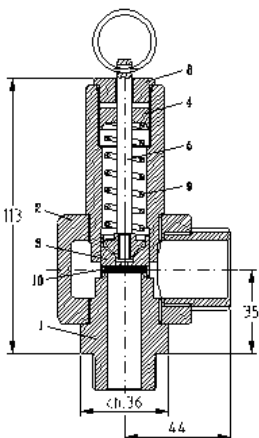
 <p>PVC14/S</p>	<p>Tipo / Type:</p>	<p>P14/A do: 14 mm</p>	
<p>Omologazione Homologation</p>	<p>PN</p>	<p>Coefficiente efflusso ridotto Low flow coefficient</p>	<p>Campo di taratura Setting range</p>
<p>E.D. 2014/68/UE IV^A Cat.(PED)</p>	<p>16</p>	<p>0,774</p>	<p>0,2 - 16 bar</p>
<p>EAC</p>	<p>/</p>	<p>/</p>	<p>/</p>
<p>ATEX Ex II 2 G c</p>	<p>/</p>	<p>/</p>	<p>/</p>
<p>ATEX Ex II 2 D c</p>	<p>/</p>	<p>/</p>	<p>/</p>
<p>ASME VIII Div.1</p>	<p>/</p>	<p>/</p>	<p>/</p>
<p>Canadian Reg. CRN</p>	<p>/</p>	<p>/</p>	<p>/</p>
 <p>PVC14/A</p>	<p style="text-align: center;">CONFIGURAZIONE - CONFIGURATION</p>		
<p>Materiale / Material</p>	<p>PVC / PVC</p>		
<p>Modelli / Model</p>	<p>Senza ghiera Without ring nut</p>	<p>/</p>	<p>/</p>
<p></p>	<p>Con anellino With ring</p>	<p>/</p>	<p>/</p>
<p></p>	<p>/</p>	<p>/</p>	<p>/</p>
<p></p>	<p>/</p>	<p>/</p>	<p>/</p>
<p></p>	<p>/</p>	<p>/</p>	<p>/</p>
<p>Sedi di Tenuta Seal System</p>	<p>N.B.R. (Std) -10 / +85 °C E.P.D.M. -15 / +85 °C VITON -15 / +85 °C SILICONE -15 / +85 °C PTFE -15 / +85 °C KALREZ -15 / +85 °C /</p>	<p>/</p>	<p>/</p>
<p>Connessione Entrata Inlet Connection</p>	<p>G.1/2" - 3/4" ISO228 / / / / / /</p>	<p>/</p>	<p>/</p>
<p>Connessione Uscita Outlet Connection</p>	<p>G.1" ISO228 / / / / / /</p>	<p>/</p>	<p>/</p>

Архангельск (8182)63-90-72
Астана (7172)727-132
Астрахань (8512)99-46-04
Барнаул (3852)73-04-60
Белгород (4722)40-23-64
Брянск (4832)59-03-52
Владивосток (423)249-28-31
Волгоград (844)278-03-48
Вологда (8172)26-41-59
Воронеж (473)204-51-73
Екатеринбург (343)384-55-89

Иваново (4932)77-34-06
Ижевск (3412)26-03-58
Иркутск (395)279-98-46
Казань (843)206-01-48
Калининград (4012)72-03-81
Калуга (4842)92-23-67
Кемерово (3842)65-04-62
Киров (8332)68-02-04
Краснодар (861)203-40-90
Красноярск (391)204-63-61
Курск (4712)77-13-04
Липецк (4742)52-20-81

Магнитогорск (3519)55-03-13
Москва (495)268-04-70
Мурманск (8152)59-64-93
Набережные Челны (8552)20-53-41
Нижний Новгород (831)429-08-12
Новокузнецк (3843)20-46-81
Новосибирск (383)227-86-73
Омск (3812)21-46-40
Орел (4862)44-53-42
Оренбург (3532)37-68-04
Пенза (8412)22-31-16

Пермь (342)205-81-47
Ростов-на-Дону (863)308-18-15
Рязань (4912)46-61-64
Самара (846)206-03-16
Санкт-Петербург (812)309-46-40
Саратов (845)249-38-78
Севастополь (8692)22-31-93
Симферополь (3652)67-13-56
Смоленск (4812)29-41-54
Сочи (862)225-72-31
Ставрополь (8652)20-65-13

Сургут (3462)77-98-35
Тверь (4822)63-31-35
Томск (3822)98-41-53
Тула (4872)74-02-29
Тюмень (3452)66-21-18
Ульяновск (8422)24-23-59
Уфа (347)229-48-12
Хабаровск (4212)92-98-04
Челябинск (351)202-03-61
Череповец (8202)49-02-64
Ярославль (4852)69-52-93

Киргизия (996)312-96-26-47 Казахстан (772)734-952-31 Таджикистан (992)427-82-92-69

<http://www.nuovagen.nt-rt.ru> || ngb@nt-rt.ru